

Features

- Frequency: 8GHz~12GHz
- Gain: 25dB
- Output P_{3dB}: 39.5dBm
- Supply Voltage: +8V
- Power-Added Efficiency: 33%@Mid-band
- Die Size: 3.97mm×4.07mm×0.1mm
- Packaged: Bare Die

General Description

The SAC3114 is a X-band GaAs MMIC power amplifier. The SAC3114 provides 25 dB of gain, and 39.5dBm of output power for 3 dB compression and more than 33%PAE from a +8V supply.

The chip has surface passivation for protection and backside via holes and gold metallisation to allow a conductive epoxy die attach process. This device is well suited for communications, Point to Point radio and radar applications.

Typical Applications

- Microwave radio including point to point communication
- Telecommunication
- Weather radar
- Optical communication
- Test instrumentation
- SatCom
- VSAT
- Military and Aerospace

Functional Diagram

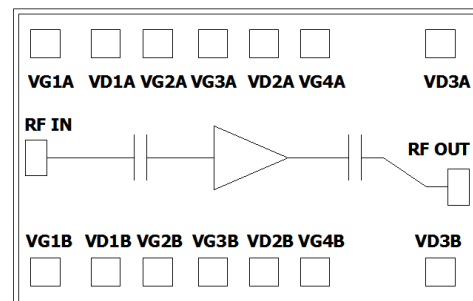

Electrical Performance

T_A=25°C, V_D=+8V, I_D=3A, Z₀=50Ω, pulse width=100uS, 10% duty cycle

Parameter	Min.	Typ.	Max.	Units
Frequency Range	8~12			GHz
Small Signal Gain	22	25	—	dB
Small Signal Gain Flatness	—	±2	—	dB
Reverse Isolation	—	-45	—	dB
Input Return Loss	—	-12	—	dB
Power-Added Efficiency	—	33	—	%
Output Power for 3 dB Compression (OP _{3dB})	39.3	40	—	dBm
Drain Voltage(V _D)	—	8	8.5	V
Gate Current	—	17	80	mA
Supply Current(I _D)	—	4	5.3	A
Thermal Resistance	—	4	—	°C/W

Absolute Maximum Ratings

Maximum Input Power	+22dBm	Operating Temperature	-40°C~+70°C
Channel Temperature	+150°C	Storage Temperature	-65°C~+150°C
Maximum V _D	+9V	Maximum V _G	-1.2V

The MMIC power dissipation is limited by the die thermal resistance, it has been designed to work in pulse mode, The SAC3114 can be operated at a duty cycle as high as 50%. Drain switch mode is the preferred control mode.

Typical Small Signal Performance Curve

The results captured in the test-jig environment within connector plan

$V_D=+8V$ $I_D=3A$

Small Signal Gain(dB) vs.Temperature

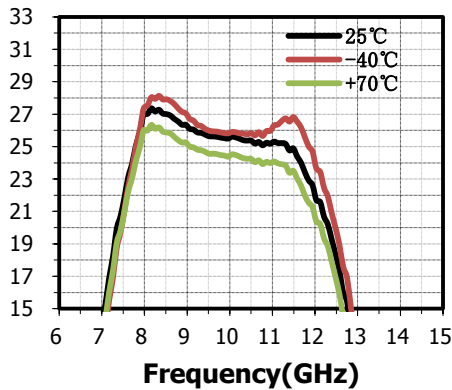

Reverse Isolation(dB) vs.Temperature

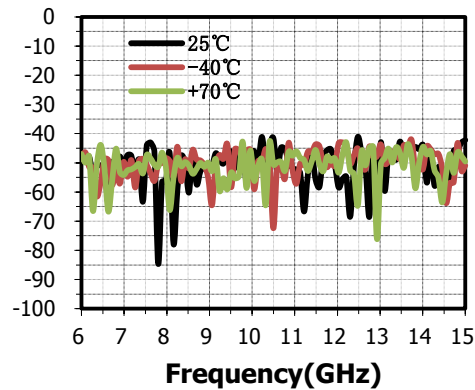

Input Return Loss(dB) vs.Temperature

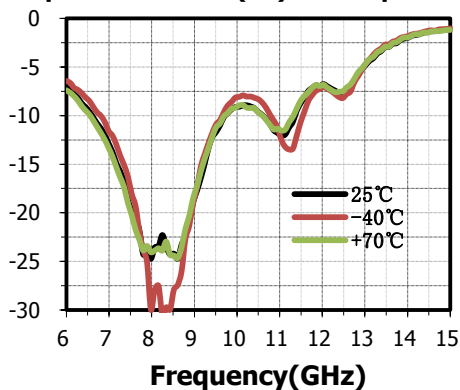

Output Return Loss(dB) vs.Temperature

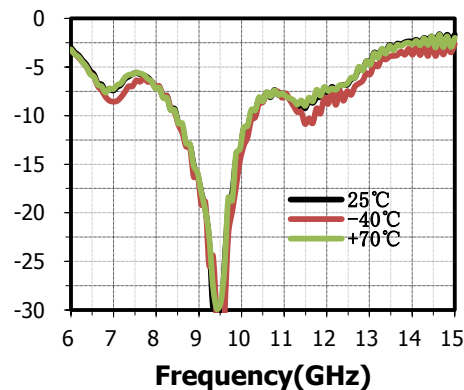

Small Signal Gain(dB) vs.Drain Supply

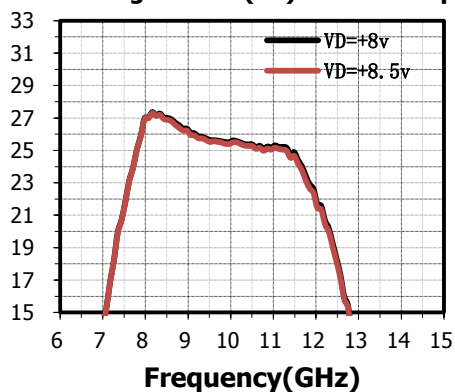

Typical Large Signal Performance Curve

The results captured in the test-jig environment within connector plan, then de-embedded the housing and come back in the die plan

$V_D = +8V$ $I_D = 3A$ Pulse width=100uS 10% Duty cycle

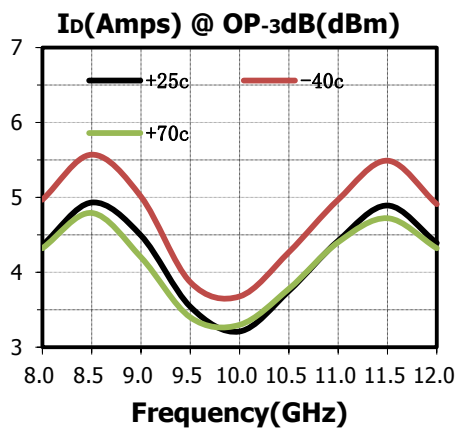
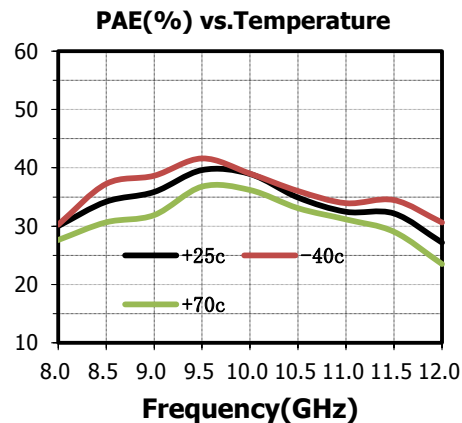
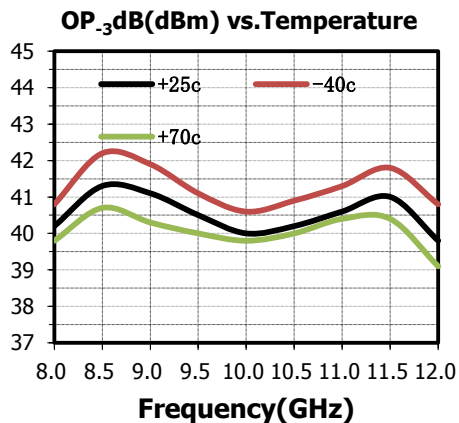

$V_D = +8V$ $I_D = 3A$ Pulse width=300uS 30% Duty cycle

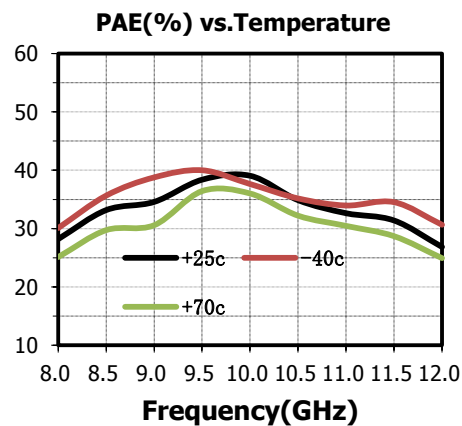
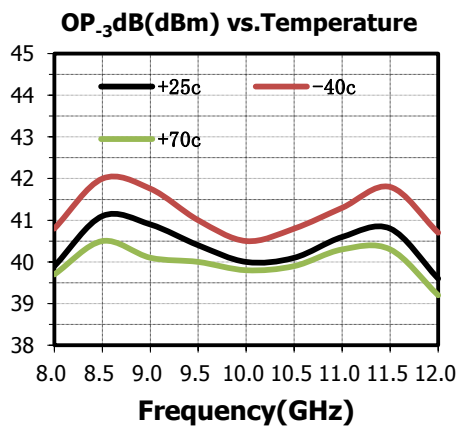

SAC3114

GaAs MMIC Power Amplifier
8GHz~12GHz 39dBm

Rev2.0

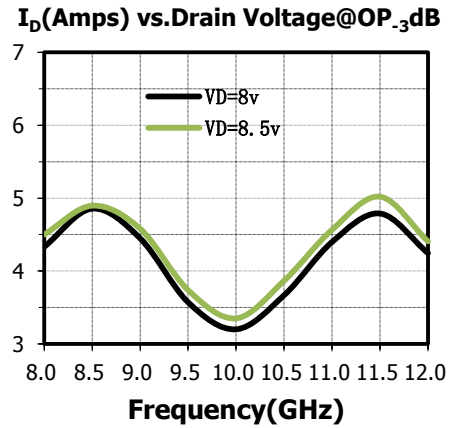
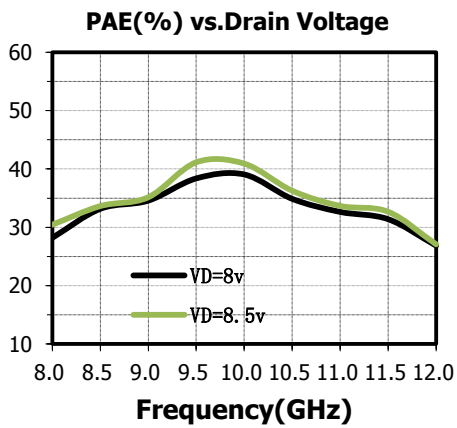
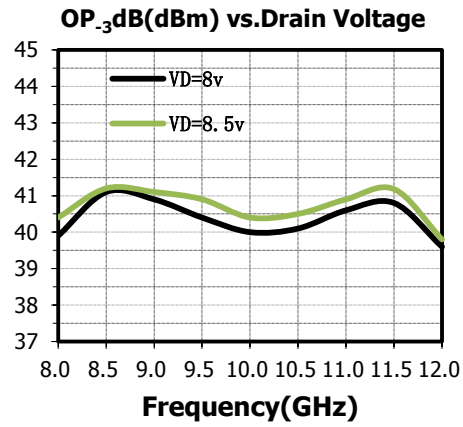
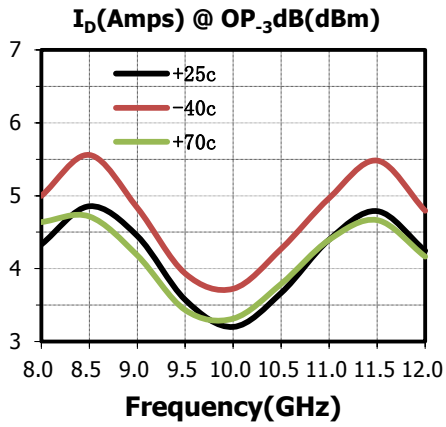

SAC3114

GaAs MMIC Power Amplifier
8GHz~12GHz 39dBm

Rev2.0

Die Outline

(all dimensions in um)

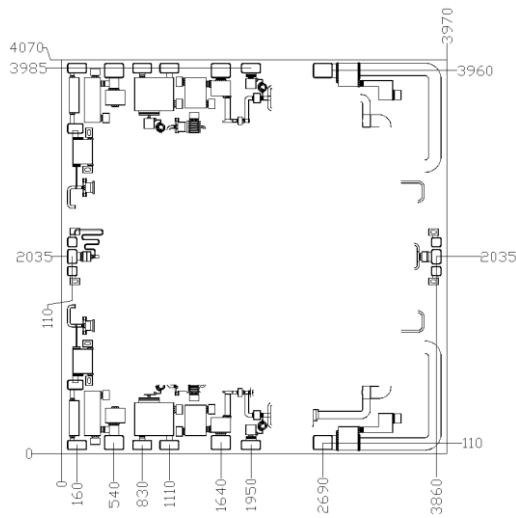

Bonding pad size:

130x80um VG, RF IN, RFOUT pads

180x130um VD pads

Assembly Diagram

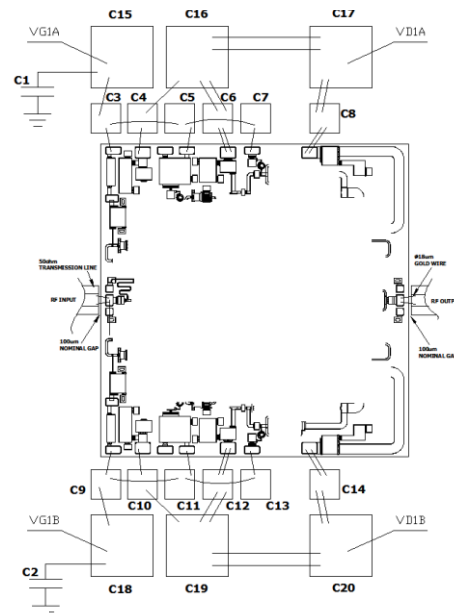

Components List

Reference Des.	Value	Part Number	Manuf.	Size
C1~C2	1uF	GRM155R61A105KE15D	Murata	0402
C3~C14	300pF	—	ANY	SLC
C15~C20	1000pF	—	ANY	SLC

Notes

1. The SAC3114 is biased with a positive drain supply and negative gate supply. The recommended gate voltage is set to -0.7~-0.85 V.
2. RF connections should be made as short as possible to reduce the inductive effect of the bond wire. Use of a 0.8 mil thermosonic wedge bonding is highly recommended as the loop height will be minimized. The RF input and output require a double bond wire as shown.
3. The backside of the SAC3114 is RF ground. Eutectic mounting is preferred, If using conductive epoxy, recommended epoxies are Die Mat DM6030HK or DM6030HK-Pt cured per the manufacturer's cure schedule. Epoxy should be applied in accordance with the manufacturers specifications and should avoid contact with the top surface of the die. An epoxy fillet should be visible around the total die periphery.
4. Bypass caps C1~C2 should be placed no farther than 1.5mm from the amplifier.

SuperApex Corporation

Address: 111 Barclay Boulevard, Ste. 211, Lincolnshire, IL 60069, USA
Tel: 1-847-573-9866, 1-847-505-8319
E-mail: sales@superapexco.com
Website: www.superapexco.com