

Features

- Frequency: 0.02~6GHz
- Gain: 20dB
- Noise Figure: 0.9dB
- Power Supply: +5V@68mA
- Bare die: 0.82mmx1.21mmx0.1mm

Typical Applications

- Microwave radio
- Telecommunication
- Weather radar
- Optical communication
- Test instrumentation
- SatCom
- VSAT
- Military and Aerospace

General Description

SAC3050 is a GaAs MMIC Low Noise Amplifier bare die which operates between 0.02 to 6GHz. The amplifier can provide 20dB gain, 19dBm OutputP₁dB, 0.9dB noise figure from a 68mA supply current.

The chip offers full passivation for increased reliability and moisture protection. This amplifier is the perfect alternative to higher cost hybrid amplifiers.

Functional Diagram

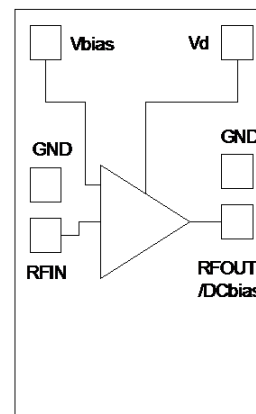

Electrical Performance (T_A=25°C, V_D= +5V, I_D=68mA, Z_O=50Ω)

Parameter	Min.	Typ.	Max.	Units
Frequency Range	0.02~6			GHz
Gain	18.5	20	22.5	dB
Gain Flatness	—	2	3	dB
Input/Output VSWR	—	1.5	1.9	:1
Noise Figure	—	0.9	1.4	dB
Reverse Isolation	—	-25	—	dB
Output Power for 1 dB Compression (OP ₁ dB)	17.5	19	—	dBm
Output Third Order Intercept (OIP ₃)	30	33	—	dBm
Output Third Order Intercept (OIP ₂)	—	48	—	dBm
Supply Current(I _D)	—	68	—	mA

Absolute Maximum Ratings

Maximum Input Power	+18dBm	Operating Temperature	-55°C~+85°C
Channel temperature	+150°C	Storage Temperature	-65°C~+150°C

SAC3050



GaAs MMIC Low Noise Amplifier
0.02~6GHz

Rev3.4

Typical Performance Curve

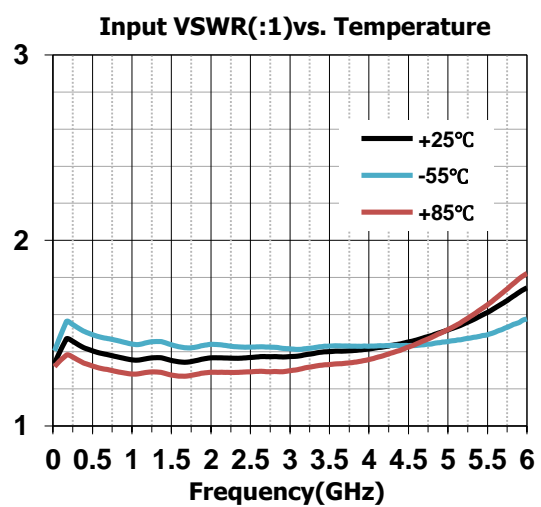
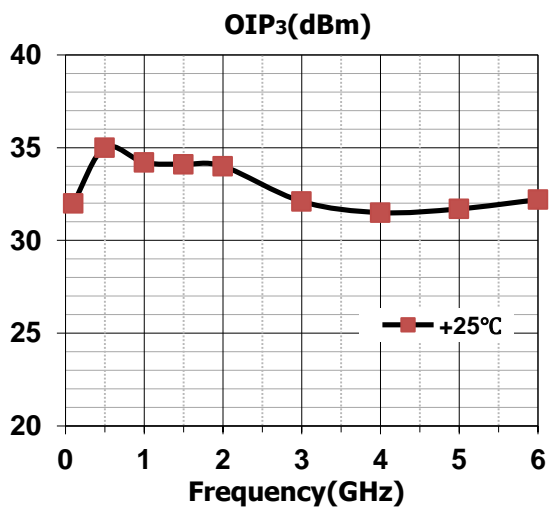
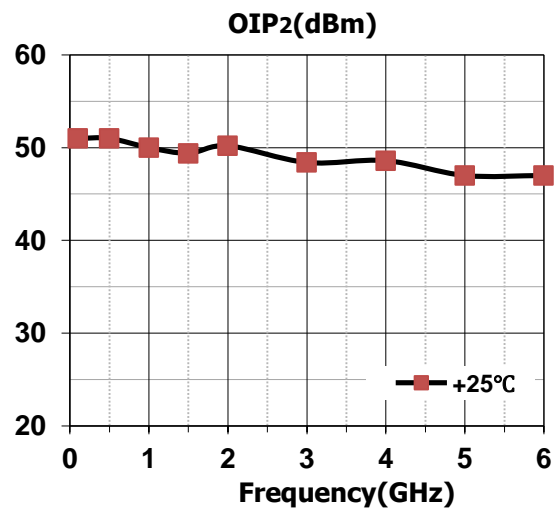
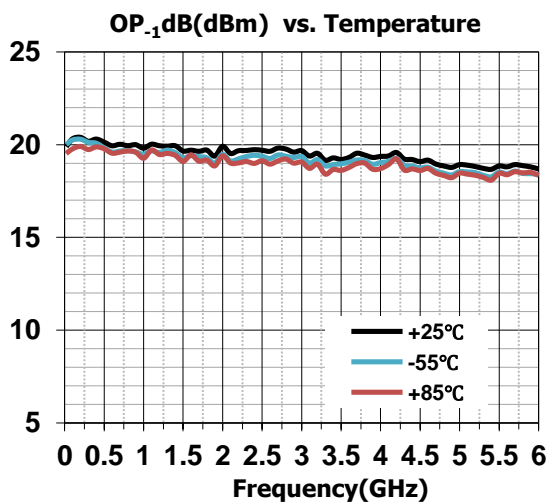
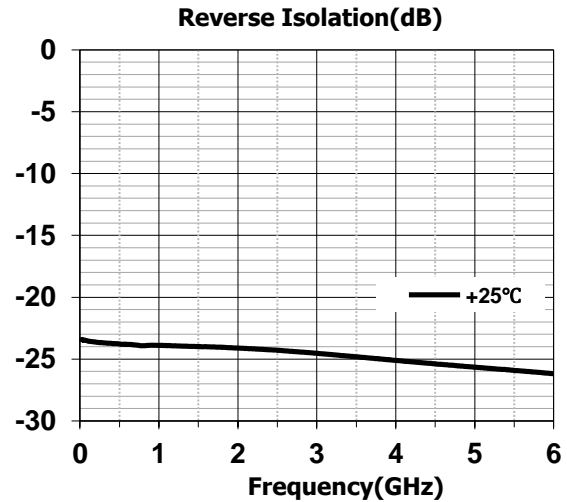
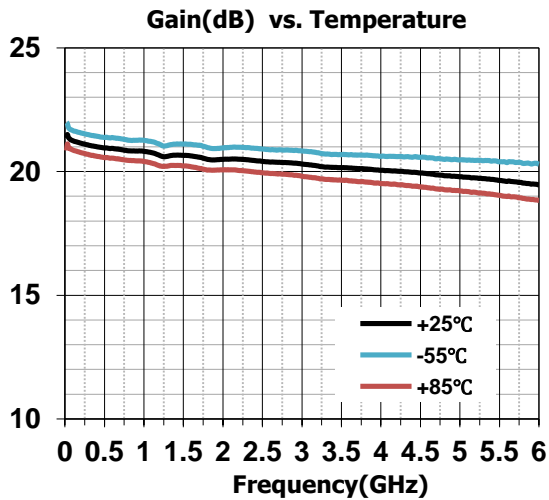

SuperApex, LLC

1580 S. Milwaukee Ave. Suite 405, Libertyville, IL 60048, USA
Tel: 1-847-505-8319, 1-847-573-9866
E-mail: sales@superapexco.com
Website: www.superapexco.com

SAC3050



GaAs MMIC Low Noise Amplifier
0.02~6GHz

Rev3.4

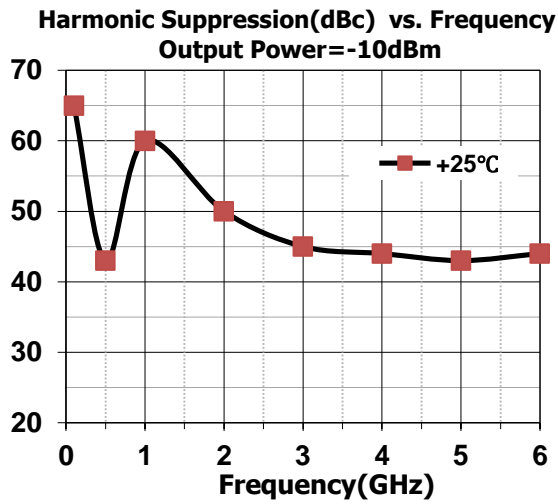
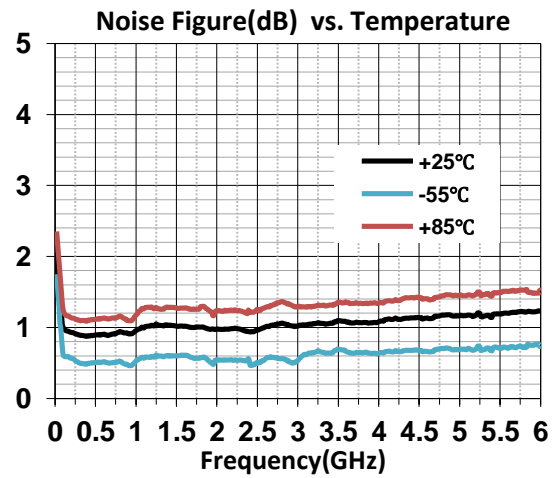
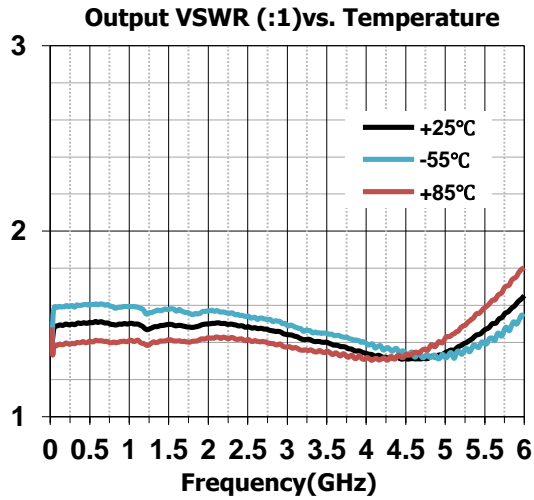

SAC3050

GaAs MMIC Low Noise Amplifier
0.02~6GHz

Rev3.4

Die Outline
(All dimensions in mm)

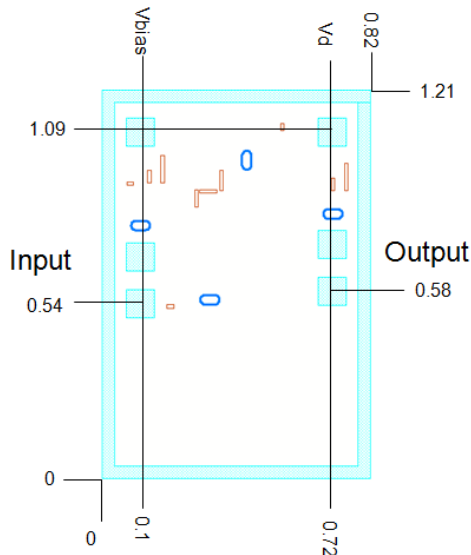

Assembly Diagram

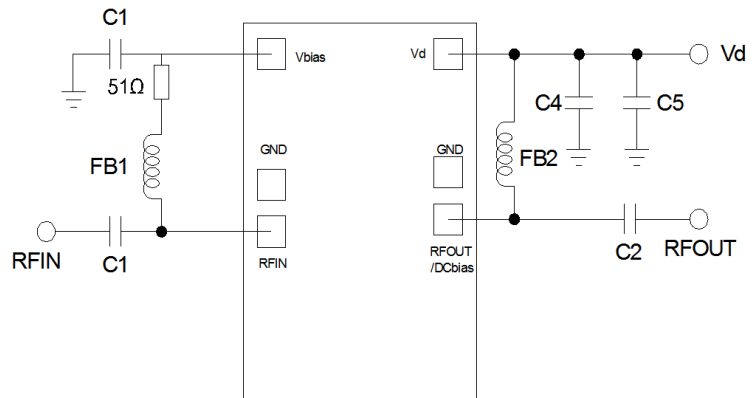

Components List

Reference Des.	Value	Part Number	Manuf.
C1,C2,C3	1000pF	GRM188R61H102KA01	MURATA
C4	100pF	GRM188R61H101KA01	MURATA
C5	10nF	GRM1857U1A103JA44	MURATA
FB1,FB2	—	MMZ1005A222ET	TDK

Attention:

GaAs MMIC devices are susceptible to damage from Electrostatic Discharge. Proper precautions should be observed during handling, assembly and test.