

# SAC3050QP3



GaAs MMIC Low Noise Amplifier  
0.02~6GHz

Rev 1.1

## Features

- Frequency: 0.02~6GHz
- Gain: 20dB
- Noise Figure: 1.0dB
- Power Supply: +5V@68mA
- Package Size: 3mmx3mmx0.75mm

## Typical Applications

- Microwave radio
- Telecommunication
- Weather radar
- Optical communication
- Test instrumentation
- SatCom
- VSAT
- Military and Aerospace

## General Description

SAC3050QP3 is a GaAs MMIC Low Noise Amplifier which operates between 0.02 to 6GHz. The amplifier can provide 20dB gain, 19dBm Output P<sub>1dB</sub>, 1.0dB noise figure from a 68mA supply current.

The device assembled in a 3x3mm plastic QFN package

## Functional Diagram

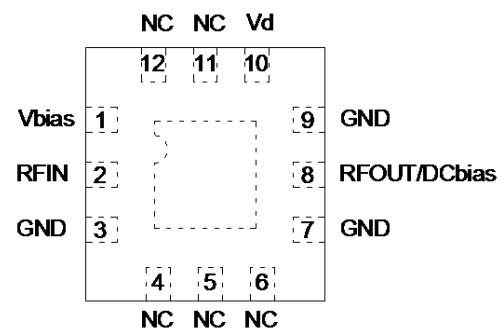

## Electrical Performance ( T<sub>A</sub>=25°C, V<sub>D</sub>=+5V, I<sub>D</sub>=68mA, Z<sub>0</sub>=50Ω )

Parameter	Min.	Typ.	Max.	Units
Frequency Range	0.02~6			GHz
Gain	18.5	20	22.5	dB
Gain Flatness	—	2	3	dB
Input/Output VSWR	—	1.5	1.9	:1
Noise Figure	—	1.0	1.5	dB
Reverse Isolation	—	-25	—	dB
Output Power for 1 dB Compression (OP <sub>1dB</sub> )	17.5	19	—	dBm
Output Third Order Intercept (OIP <sub>3</sub> )	30	33	—	dBm
Output Third Order Intercept (OIP <sub>2</sub> )	—	48	—	dBm
Supply Current(I <sub>D</sub> )	—	68	—	mA

## Absolute Maximum Ratings

Maximum Input Power	+18dBm	Operating Temperature	-55°C~+85°C
Channel temperature	+150°C	Storage Temperature	-65°C~+150°C

## SuperApex, LLC

1580 S. Milwaukee Ave. Suite 405, Libertyville, IL 60048, USA  
Tel: 1-847-505-8319, 1-847-573-9866  
E-mail: sales@superapexco.com  
Website: www.superapexco.com

# SAC3050QP3



GaAs MMIC Low Noise Amplifier  
0.02~6GHz

Rev 1.1

## Typical Performance Curve

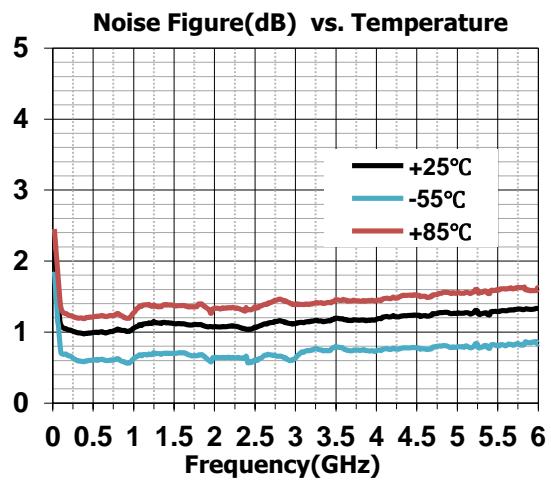
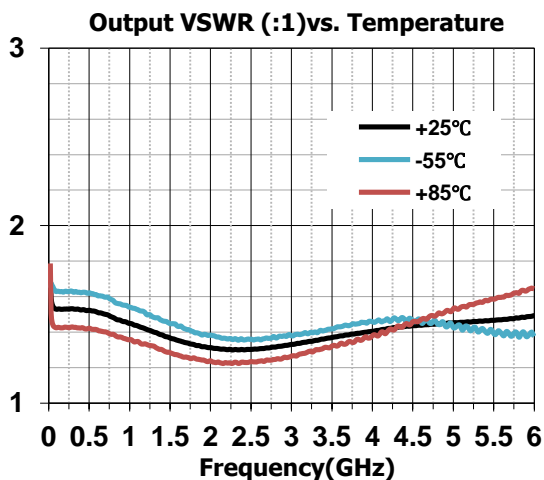
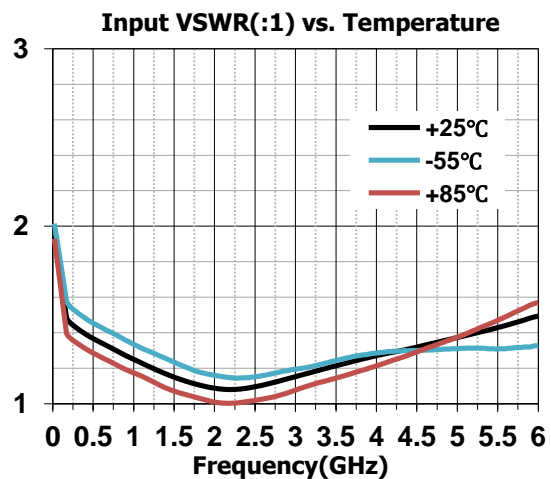
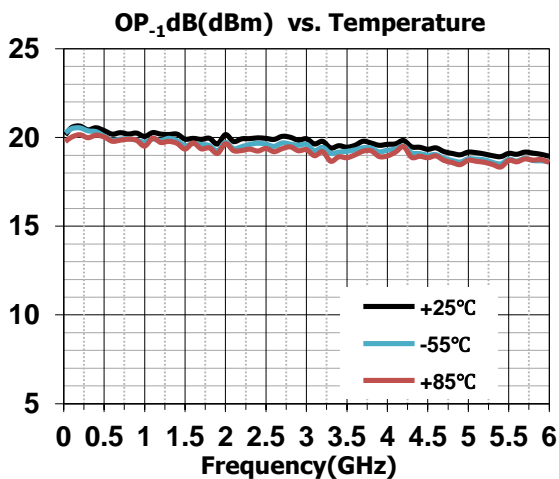
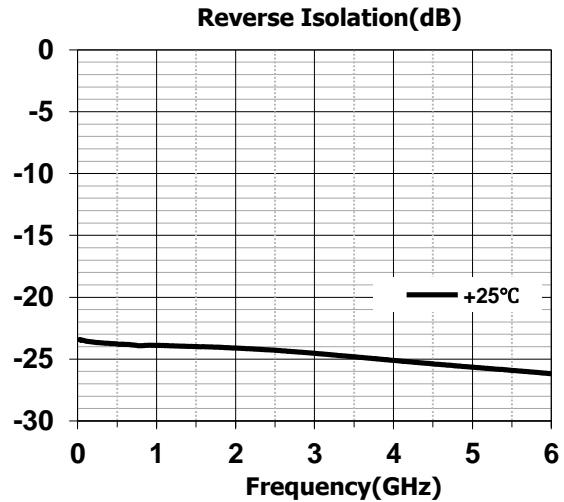
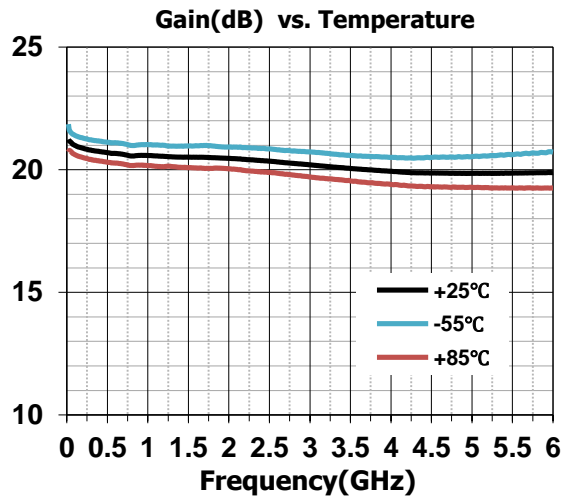

### SuperApex, LLC

1580 S. Milwaukee Ave. Suite 405, Libertyville, IL 60048, USA  
Tel: 1-847-505-8319, 1-847-573-9866  
E-mail: sales@superapexco.com  
Website: www.superapexco.com

# SAC3050QP3

GaAs MMIC Low Noise Amplifier  
0.02~6GHz

Rev 1.1

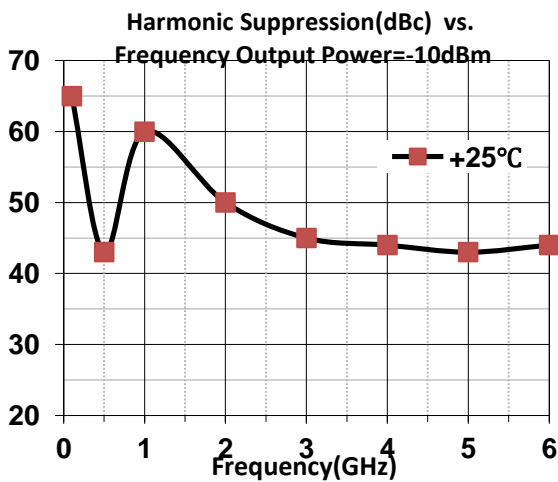
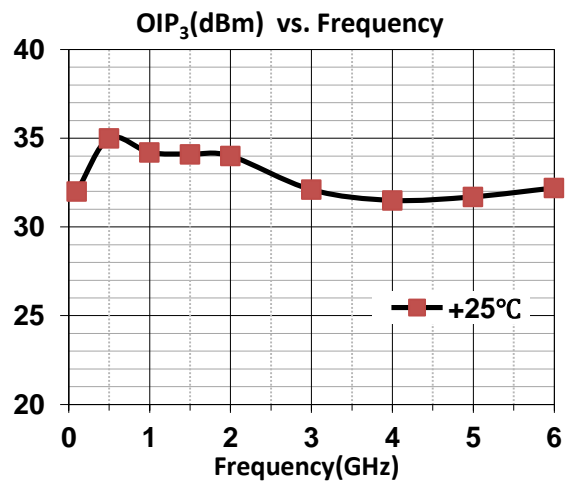
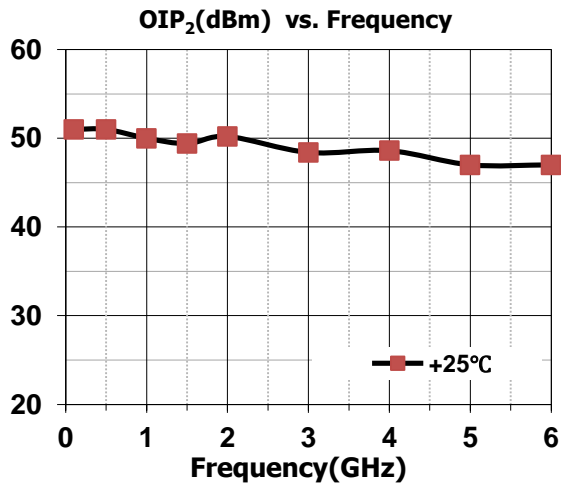

## Outline Drawing (all dimensions in mm)

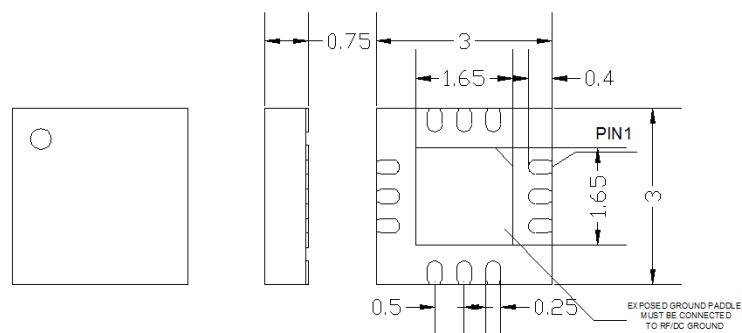

# SAC3050QP3

GaAs MMIC Low Noise Amplifier  
0.02~6GHz

Rev 1.1

## Application Circuit Configuration

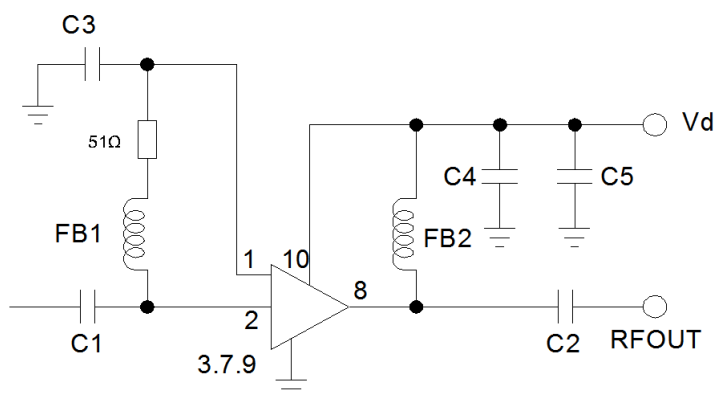

## Components List

Reference Des.	Value	Part Number	Manuf.
C1,C2,C3	1000pF	GRM188R61H102KA01	MURATA
C4	100pF	GRM188R61H101KA01	MURATA
C5	10nF	GRM1857U1A103JA44	MURATA
FB1,FB2	—	MMZ1005A222ET	TDK

### Attention:

1. The moisture resistant grade of products is 2A, the storage environment  $\leq 30^{\circ}$  C/60% RH, The surrounding workshop Life is 4 weeks. 2. After un-packing, It is necessary to bake the parts for 6 hours in 125+/-5 degree environment before soldering.