

Features

- Frequency Range: DC~20GHz
- Isolation: >40dB@20GHz
- Insertion loss: 1.8dB@20GHz
- Non-reflective Switch
- Die Size: 1.32mm×1.21 mm×0.1mm

Typical Applications

- Radar and ECM
- RF/ Microwave Radio
- Military and Space
- Test and Measurement
- Fiber Optics

General Description

SAC3201A is a general-purpose broadband high isolation non-reflective GaAs pHEMT SPDT switch in bare die. The switch offers over 40dB isolation and less than 1.8 dB insertion loss over operation frequency. Fast switching and compact size make this absorptive SPDT ideal for a lot of critical applications.

The switch operates using complementary negative control voltage logic lines of 0/-5V and requires no bias supply.

Functional Diagram

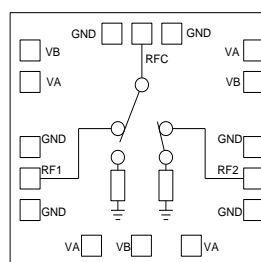

Electrical Performance

TA=25°C, Control Voltage=0/-5V, 50Ω

Parameter	Freq.	Min.	Typ.	Max.	Units
Insertion loss	DC~20GHz	-	1.8	-	dB
Isolation	DC~20GHz	40	50	-	dB
Return Loss(RFC(ON))	DC~20GHz	-	-15	-	dB
Return Loss(RF1,RF2(OFF))	DC~20GHz	-	-20	-	dB
Switching Speed (50% V _{CTL} to 90% of RF output)	DC~20GHz	-	20	-	ns

Logic Voltage

State	Bias
LOW	0~0.2V
HIGH	-3~-6V

Truth Table

Control Input		Signal Path State	
VA	VB	RFC-RF1	RFC-RF2
HIGH	LOW	ON	OFF
LOW	HIGH	OFF	ON

Absolute Maximum Ratings

RF Input Power (0.5 GHz ~20GHz)	+30dBm	Operating Temperature	-55°C ~ +85°C
Control Voltage Range	-6~0.2V	Storage Temperature	-65°C ~ +150°C
ESD Sensitivity (HBM)	Class 1A	Channel Temperature	150°C

Typical Performance Curve

Return Loss(dB) vs. Frequency

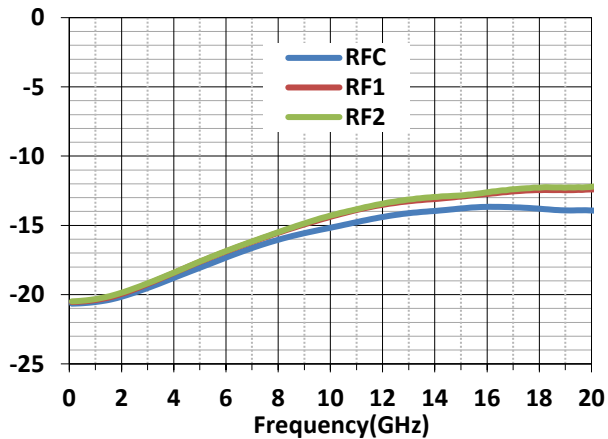

Return Loss(dB) vs. Frequency

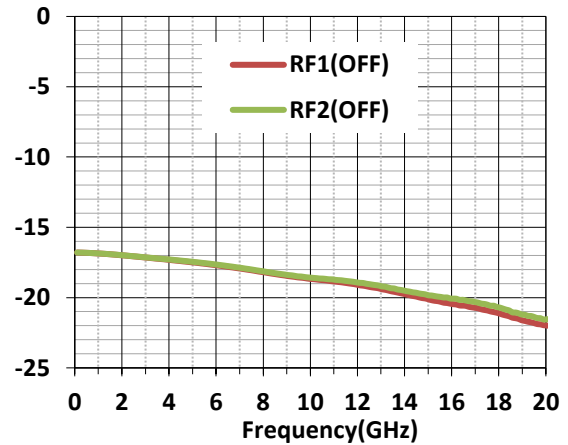

Insertion Loss(dB) vs. Frequency

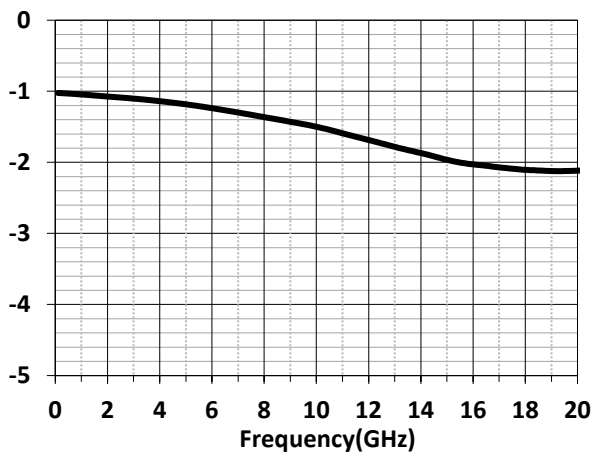

Isolation vs. Frequency

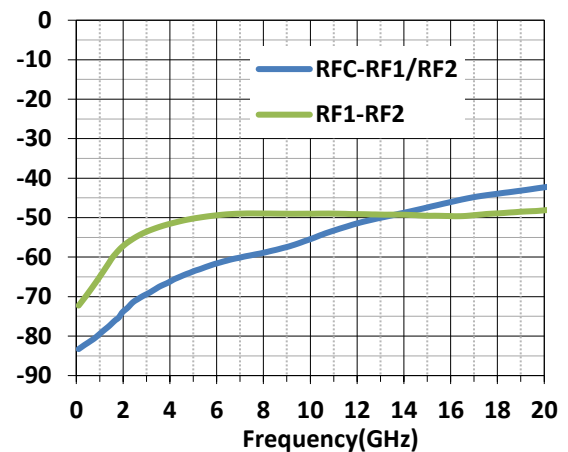

Input P-1dB(dBm) vs. Frequency

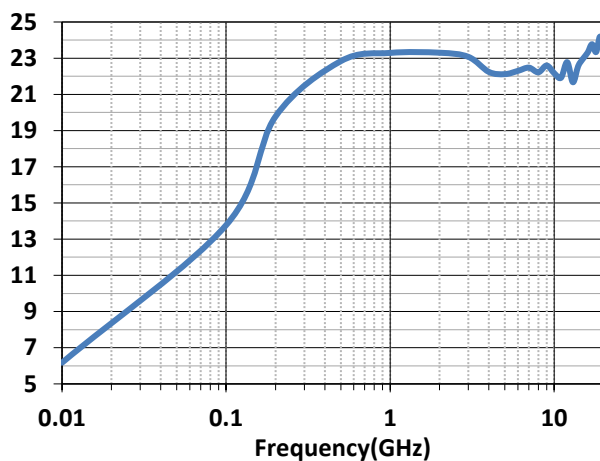

SAC3201A



GaAs MMIC SPDT Switch
DC~20GHz

Rev 1.2

Switching Speed (ON)

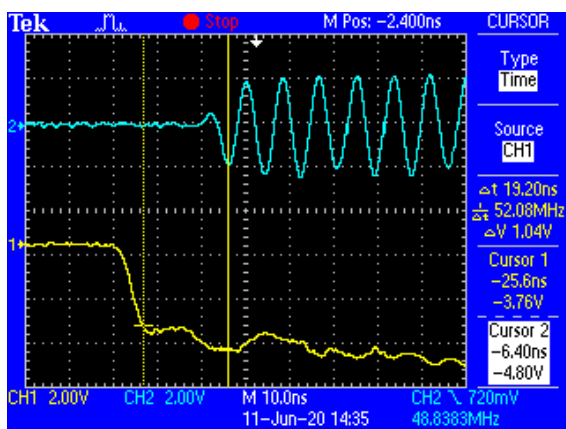

Switching Speed (OFF)

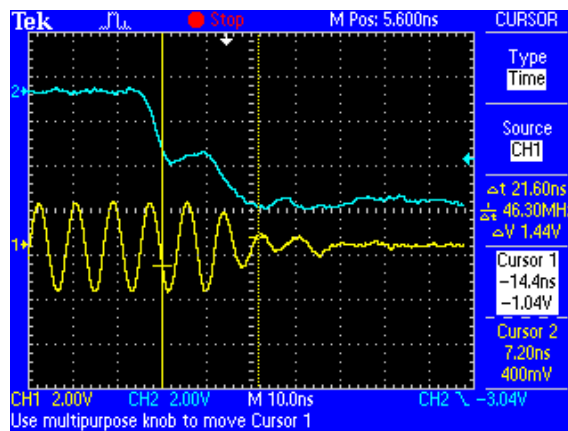

Die Outline

(All dimensions in mm)

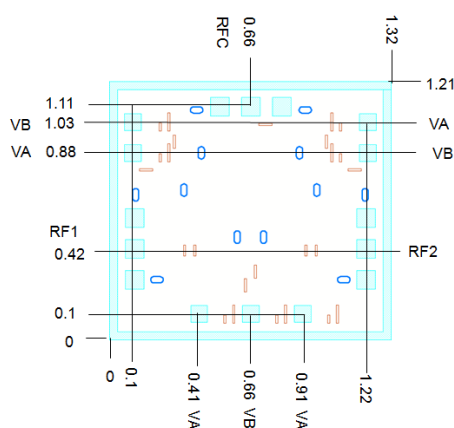

Assembly Diagram

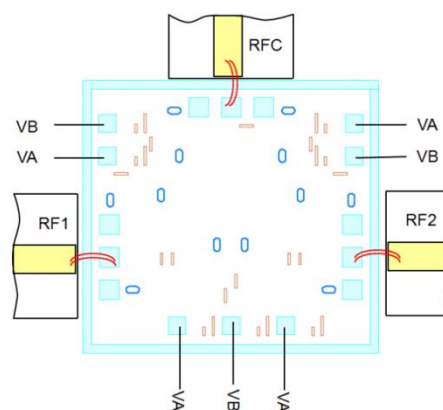

VA, VB internal connection, just connect anyone.

Attention:

GaAs MMIC devices are susceptible to damage from Electrostatic Discharge. Proper precautions should be observed during handling, assembly and test.

SuperApex, LLC

1580 S. Milwaukee Ave. Suite 405, Libertyville, IL 60048, USA
Tel: 1-847-505-8319, 1-847-573-9866
E-mail: sales@superapexco.com
Website: www.superapexco.com