

SAC3311AQ6



GaAs MMIC 6-BIT DIGITAL PHASE SHIFTER
1.2~1.8GHz

Rev 1.0

Features

- Frequency: 1.2~1.8GHz
- RMS of Phase Accuracy: 1°
- Low Insertion Loss: 4.7dB
- Positive Voltage Control
- Package Size: 6mm×6mm×1.3mm

Typical Applications

- EW
- Military Radar and Weather Radar
- SATCOM
- Beamforming Modules
- Phase Cancellation

General Description

SAC3311AQ6 is a 6-bit digital phase shifter which works from 1.2 to 1.8GHz, providing 360 degrees of phase coverage with a LSB of 5.625 degrees.

SAC3311AQ6 features very low RMS phase error of 1 degrees and extremely low insertion loss variation of ± 0.3 dB across all phase states. This high accuracy phase shifter is controlled with positive control voltage of 0/+5V.

Functional Diagram

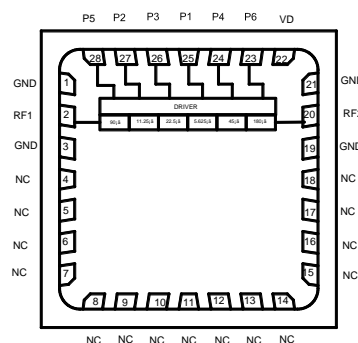

Electrical Performance

$T_A = +25^\circ\text{C}$, $V_{DD} = -5\text{V}$, Control Voltage = 0/+5V, $Z_0 = 50\Omega$

Parameter	Min.	Typ.	Max.	Units
Frequency		1.2~1.8		GHz
Input VSWR	—	1.4	—	:1
Output VSWR	—	1.4	—	:1
Insertion Loss	—	-4.7	—	dB
IL Variation	—	± 0.3	—	dB
Phase Accuracy	—	± 2	—	°
RMS of Phase Accuracy	—	1	—	°

Truth Table (0: 0V, 1: +5V)

Phase	P1	P2	P3	P4	P5	P6
REF	0	0	0	0	0	0
-5.625°	1	0	0	0	0	0
-11.25°	0	1	0	0	0	0
-22.5°	0	0	1	0	0	0
-45°	0	0	0	1	0	0
-90°	0	0	0	0	1	0
-180°	0	0	0	0	0	1
-354.375°	1	1	1	1	1	1

SuperApex, LLC

1580 S. Milwaukee Ave. Suite 405, Libertyville, IL 60048, USA
Tel: 1-847-505-8319, 1-847-573-9866
E-mail: sales@superapexco.com
Website: www.superapexco.com

SAC3311AQ6



GaAs MMIC 6-BIT DIGITAL PHASE SHIFTER
1.2~1.8GHz

Rev 1.0

Absolute Maximum Ratings

Maximum Input Power	+23dBm	Operating Temperature	-55°C~+85°C
Maximum Input Voltage	-5.5V	Storage Temperature	-65°C~+150°C

Control Voltage

State	Bias
Low	0~0.2V
High	3.0~5.5V

Power Supply

V _D	I _D
-5V	8mA

Typical Performance Curve

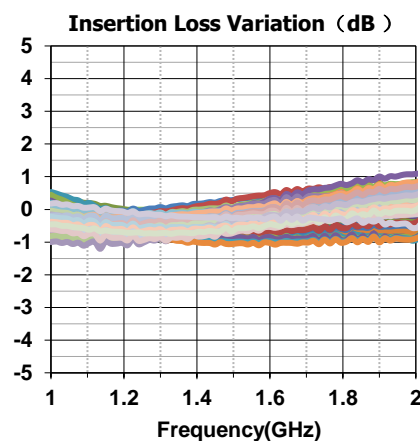
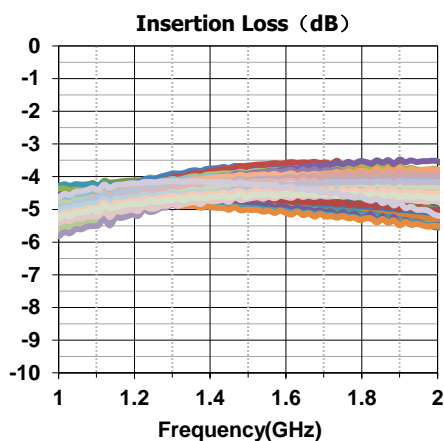
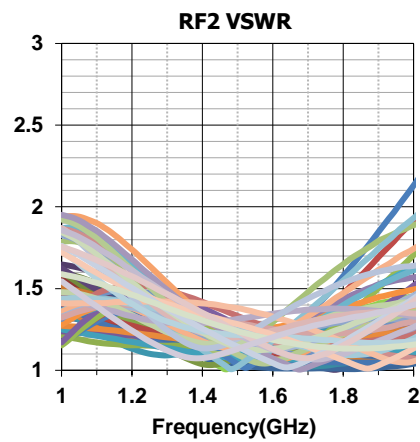
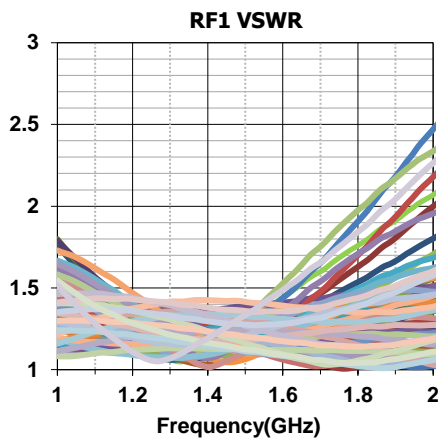

SuperApex, LLC

1580 S. Milwaukee Ave. Suite 405, Libertyville, IL 60048, USA
Tel: 1-847-505-8319, 1-847-573-9866
E-mail: sales@superapexco.com
Website: www.superapexco.com

SAC3311AQ6

GaAs MMIC 6-BIT DIGITAL PHASE SHIFTER
1.2~1.8GHz

Rev 1.0

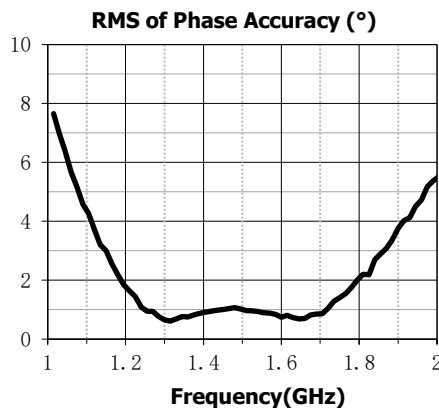
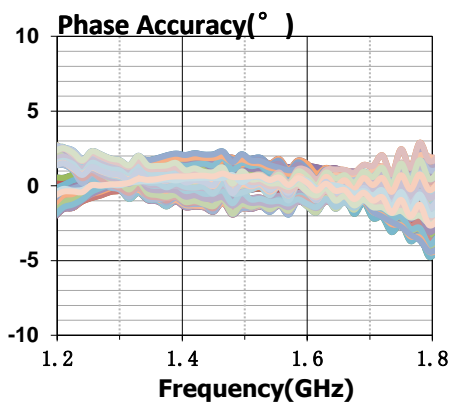

Die Outline

All dimensions in mm

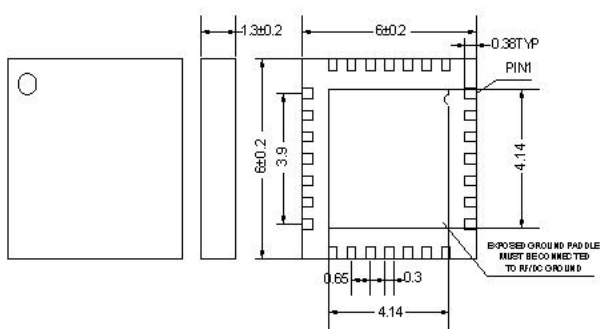

Assembly Diagram

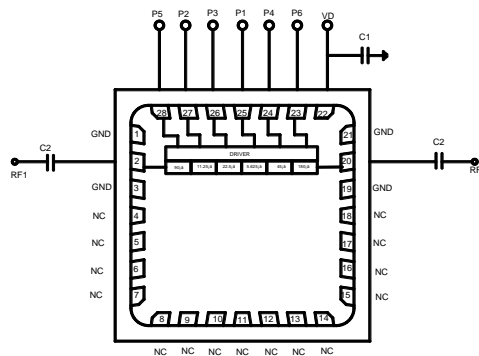

Components List

Reference Des.	Value	Part Number	Manuf.	Size
C1	1000pF	GRM1555C1H102JA1D	Murata	0402
C2	51pF	GRM1555C1H510JA01D	Murata	0402

Attention:

1. The moisture resistant grade of products is 2A, the storage environment $\leq 30^{\circ}\text{C}/60\% \text{RH}$, the surrounding workshop Life is 4 weeks.
2. After un-packing, it is necessary to bake the parts for 6 hours in $125\pm 5^{\circ}\text{C}$ environment before soldering.