

# SAC3154Q8



GaAs MMIC Power Amplifier  
5GHz~8GHz 38.5dBm

Rev 1.2

## Features

- Frequency: 5GHz~8GHz
- Small Signal Gain: 23dB
- Output P<sub>-1dB</sub>: 38.5dBm
- Package size: QFN8x8
- Supply Voltage: +8V/-Vg

## Typical Applications

- Point-to-Point Radios

## General Description

SAC3154Q8 is a C-band GaAs MMIC power amplifier. SAC3154Q8 provides 23dB of gain, and 38.5dBm of output power for 1 dB compression from +8V supply.

## Electrical Performance

T<sub>A</sub>=25°C, V<sub>D</sub>=+8V, I<sub>DQ</sub>=2.5A, Z<sub>0</sub>=50Ω, CW

Parameter	Min.	Typ.	Max.	Units
Frequency Range	5	—	8	GHz
Small Signal Gain	20	23	—	dB
Small Signal Gain Flatness	—	±2	—	dB
Reverse Isolation	—	-70	—	dB
RF Input Port Return Loss	—	-8	—	dB
Output P <sub>-1dB</sub>	37.5	38.5	—	dBm
Drain Voltage (V <sub>D</sub> )	8	—	8.5	V
Gate Current	—	2	26	mA
Supply Current (I <sub>D</sub> )***	—	—	5.5	A
Thermal Resistance**	—	2.9	—	°C/W

\*\* Measurement taken at P<sub>out</sub> = OP<sub>-1dB</sub>, IR method. 100% DC power is dissipated on the device the thermal resistance is 3.3°C/W.

\*\*\* Adjust V<sub>g</sub> between -1.5V to -0.4V to achieve I<sub>DQ</sub>= 2.5A, and typical V<sub>g</sub> voltage is -0.8V.

## Absolute Maximum Ratings

Maximum Input Power	+24dBm	Operating Temperature (Backside)	-55°C~+85°C
Channel Temperature	150°C	Storage Temperature	-55°C~+150°C
Maximum V <sub>D</sub>	+8.5V	V <sub>G</sub> Range	-3V~-0.4V

## SuperApex, LLC

1580 S. Milwaukee Ave. Suite 405, Libertyville, IL 60048, USA  
Tel: 1-847-505-8319, 1-847-573-9866  
E-mail: sales@superapexco.com  
Website: www.superapexco.com

# SAC3154Q8



GaAs MMIC Power Amplifier  
5GHz~8GHz 38.5dBm

Rev 1.2

## Typical Performance Curve

$V_D = +8V, I_{DQ} = 2.5A, CW, T_A = +25^\circ C$

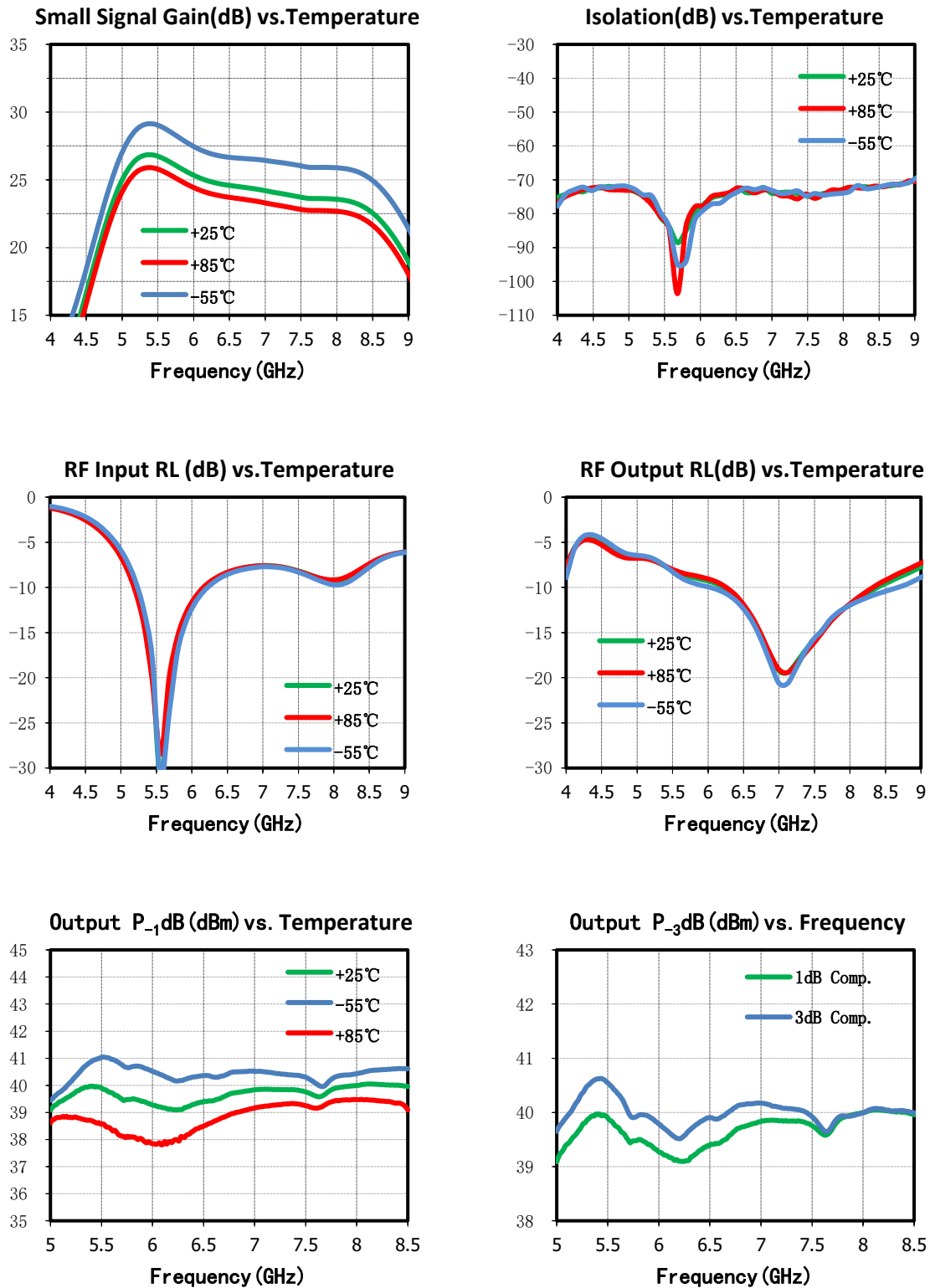

### SuperApex, LLC

1580 S. Milwaukee Ave. Suite 405, Libertyville, IL 60048, USA  
Tel: 1-847-505-8319, 1-847-573-9866  
E-mail: sales@superapexco.com  
Website: www.superapexco.com

# SAC3154Q8



GaAs MMIC Power Amplifier  
5GHz~8GHz 38.5dBm

Rev 1.2

IM3 (dBc) vs. Pout/Tone

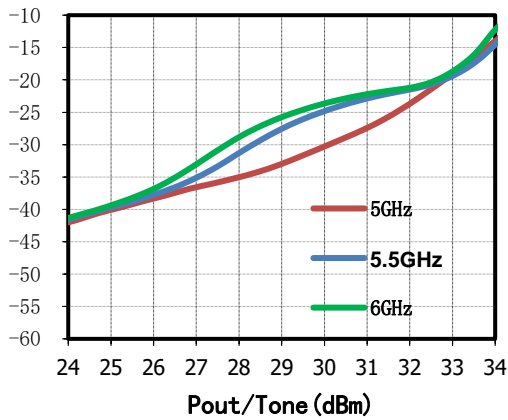

IM3 (dBc) vs. Pout/Tone

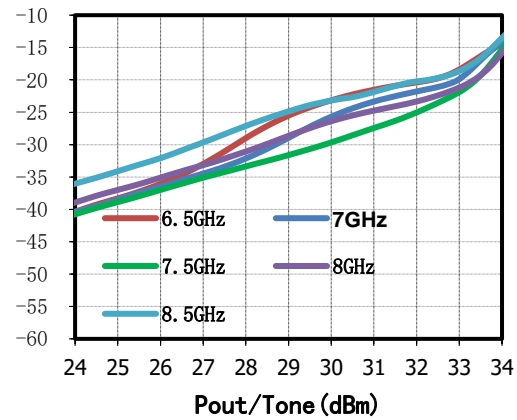

IM5 (dBc) vs. Pout/Tone

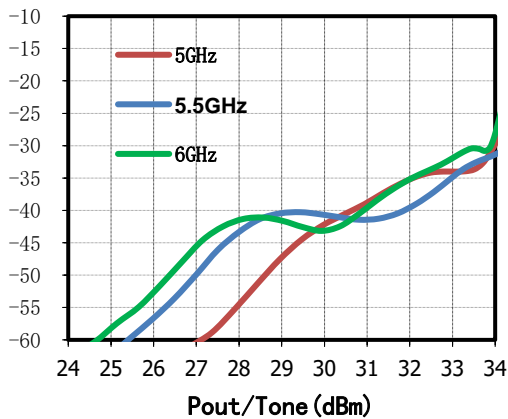

IM5 (dBc) vs. Pout/Tone

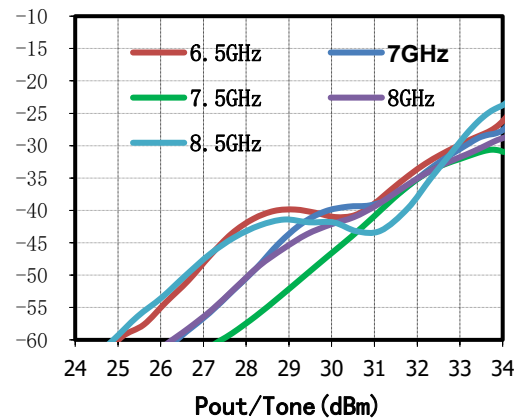

2<sup>ND</sup> Harmonic Rej. vs. Frequency

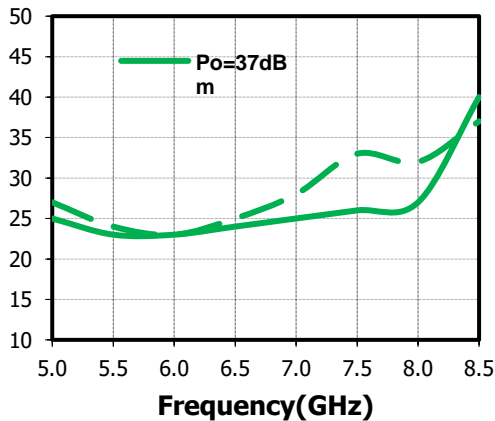

3<sup>RD</sup> Harmonic Rej. vs. Frequency

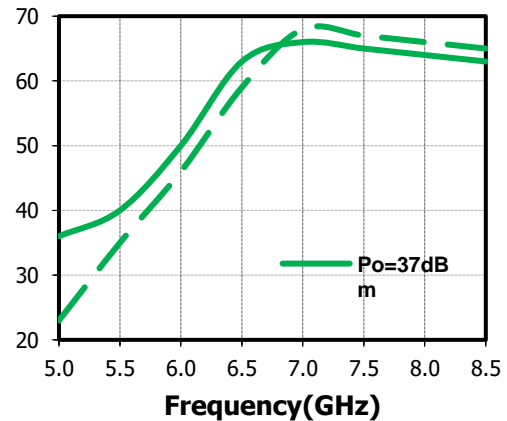

# SAC3154Q8



GaAs MMIC Power Amplifier  
5GHz~8GHz 38.5dBm

Rev 1.2

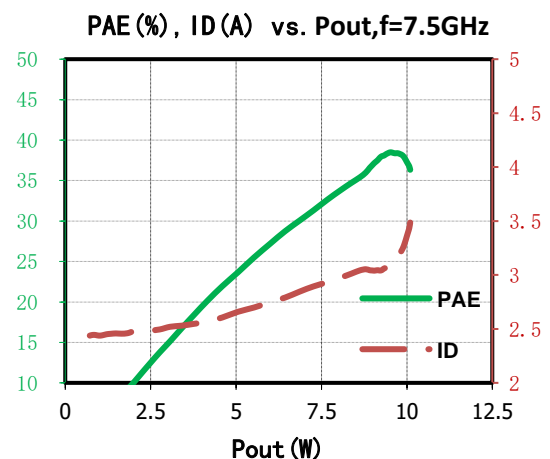
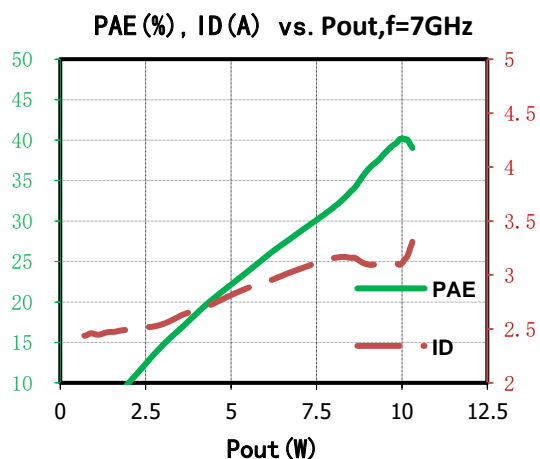
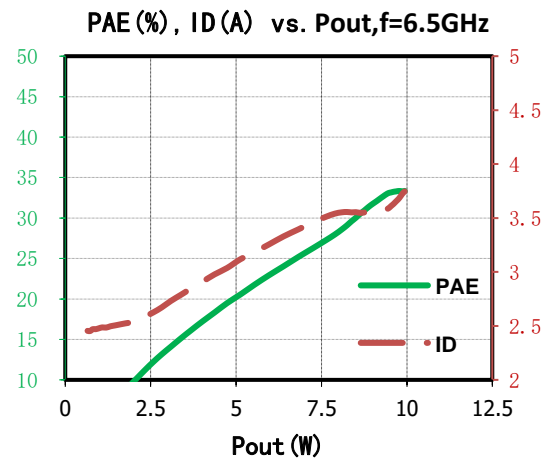
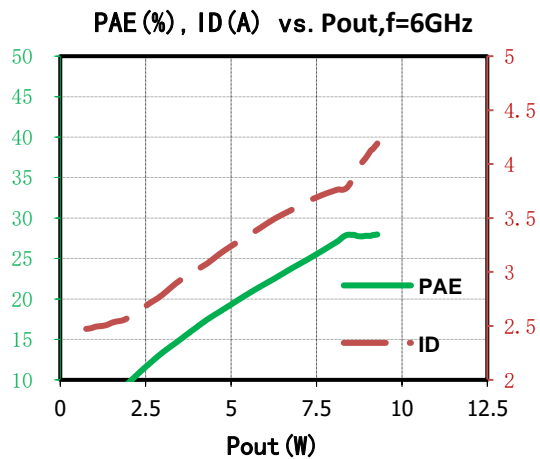
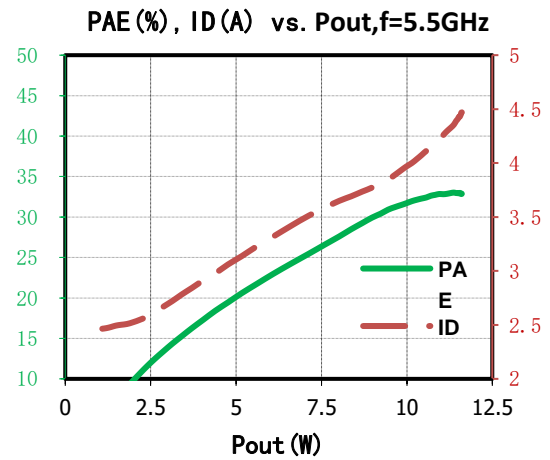
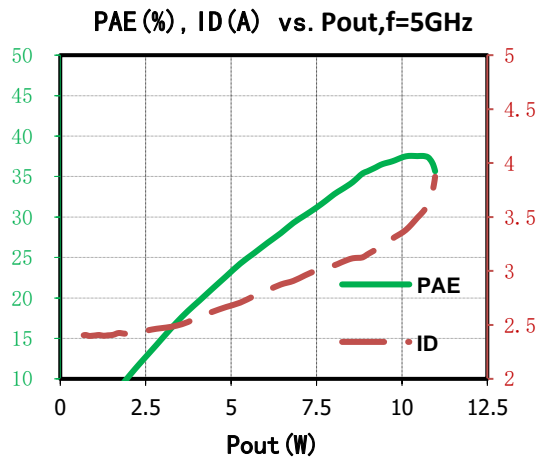

# SAC3154Q8



GaAs MMIC Power Amplifier  
5GHz~8GHz 38.5dBm

Rev 1.2

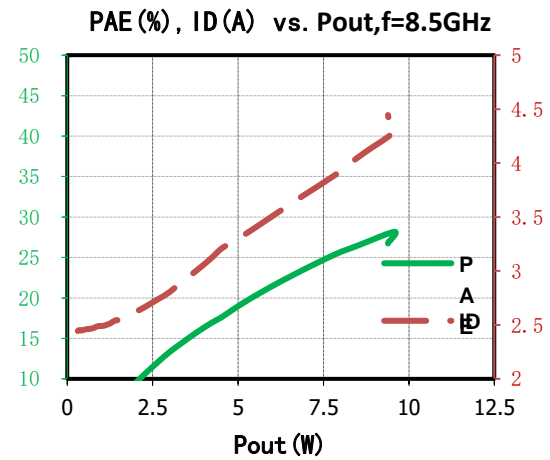
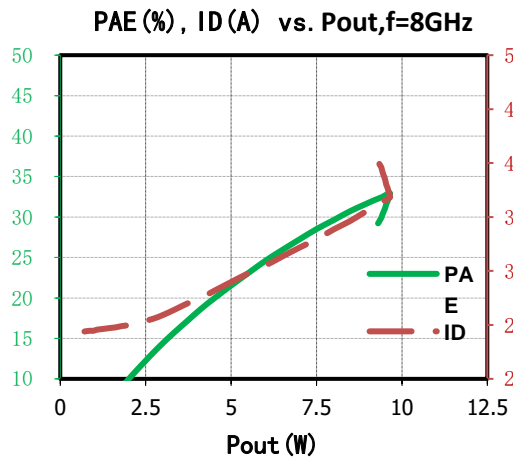

## Outline Dimension (mm)

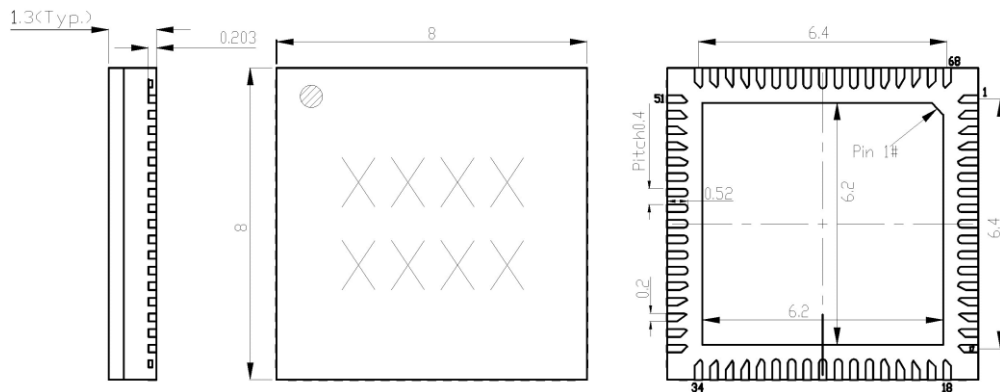

## Application Circuit

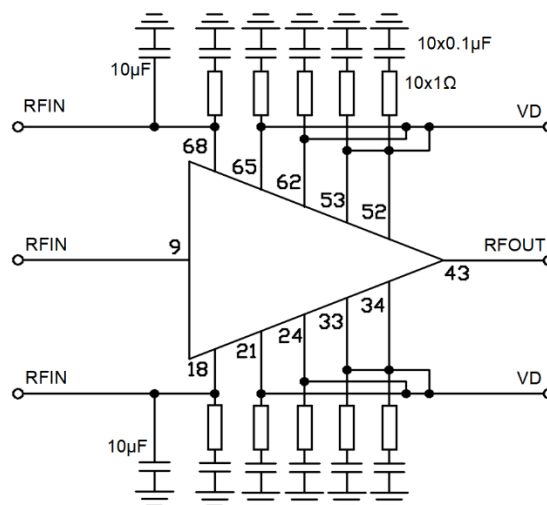

### SuperApex, LLC

1580 S. Milwaukee Ave. Suite 405, Libertyville, IL 60048, USA  
 Tel: 1-847-505-8319, 1-847-573-9866  
 E-mail: sales@superapexco.com  
 Website: www.superapexco.com

## Pin Descriptions

Pin No.	Function	Pin No.	Function	Pin No.	Function	Pin No.	Function	Pin No.	Function
1	GND	15	GND	29	GND	43	RFOUT	57	GND
2	GND	16	GND	30	VDAUX	44	GND	58	VDAUX
3	GND	17	GND	31	VDAUX	45	GND	59	VDAUX
4	GND	18	VG1	32	GND	46	GND	60	GND
5	GND	19	GND	33	VD3B	47	GND	61	GND
6	GND	20	GND	34	VD3B	48	GND	62	VD2A
7	GND	21	VD1B	35	GND	49	GND	63	GND
8	GND	22	GND	36	GND	50	GND	64	GND
9	RFIN	23	GND	37	GND	51	GND	65	VD1A
10	GND	24	VD2B	38	GND	52	VD3A	66	GND
11	GND	25	GND	39	GND	53	VD3A	67	GND
12	GND	26	GND	40	GND	54	GND	68	VG2
13	GND	27	VDAUX*	41	GND	55	VDAUX		
14	GND	28	VDAUX	42	GND	56	VDAUX		

\*The VDAUX pins should be keep floating or connect to VD together.

## Evaluation Board

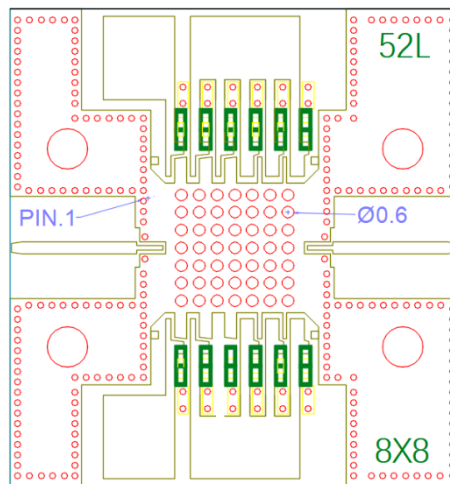

Superapex recommend the PCB fabricated using Rogers 4350b t=0.254 and using best practices for high frequency RF design. The RF input and RF output traces should have a 50 Ω characteristic impedance.

The bottom center pad of SAC3154Q8 is used for RF grounding and heat dissipation. For best heat dissipation, copper-filled vias are highly recommended, SAC3154Q8 is high power dissipation surface mount components and require a well-designed thermal mount. All the heat generated by the device is expected to be removed through the bottom heat slug with a low thermal resistance path to the chassis.

The use of multiple copper-filled vias or solder-filled vias under the package's heat slug while using a indium foil between the PCB and chassis provides a low thermal resistance mount, Insufficient number of vias or insufficient solder filling will significantly affect the heat dissipation process of the device, and then reduce the performance or even damage the device.

### SuperApex, LLC

1580 S. Milwaukee Ave. Suite 405, Libertyville, IL 60048, USA  
Tel: 1-847-505-8319, 1-847-573-9866  
E-mail: sales@superapexco.com  
Website: www.superapexco.com

# SAC3154Q8



GaAs MMIC Power Amplifier  
5GHz~8GHz 38.5dBm

Rev 1.2

## Notes

1. SAC3154Q8 requires VDx and VGx bias.  
Turn-on: Apply VGx, apply VDx, apply RFIN signal.  
Turn-off: Remove RFIN signal, decrease VG to -1.5 V (pinch-off), decrease VD to 0 V
2. The moisture resistant grade of products is 2a, the storage environment  $\leq 30^{\circ}\text{C}/60\% \text{RH}$ , the surrounding workshop life is 4 weeks;
3. After un-packing, it is necessary to bake the parts for 6 hours in  $125\pm 5^{\circ}$  environment before soldering;
4. GaAs MMIC devices are susceptible to damage from Electrostatic Discharge. Proper precautions should be observed during handling, assembly and test;
5. Ultrasonic cleaning is prohibited.

## Revision History

Revision	Date	Comment
1.0	Sep. 18, 2023	First Release
1.1	Jan.2,2024	Revise Pin Descriptions
1.2	Jan.3,2024	Update Pin Descriptions

---

### SuperApex, LLC

1580 S. Milwaukee Ave. Suite 405, Libertyville, IL 60048, USA  
Tel: 1-847-505-8319, 1-847-573-9866  
E-mail: sales@superapexco.com  
Website: www.superapexco.com