

SAC5008CR12



GaN MMIC Power Amplifier
5GHz~8GHz 48dBm

Rev 1.0

Features

- Frequency: 5GHz~8GHz
- Small Signal Gain: 28dB
- CW Output Power: 48dBm
- PAE: 30%
- Package: Flange (CR12)
- Supply Voltage: +28V/-Vg

Typical Applications

- Point-to-Point Radios

General Description

SAC5008CR12 is a C-band power amplifier in a ceramic frame package with a flange and straight RF and DC leads for drop-in assembly that delivering 48dBm with 30% power added efficiency from 5GHz to 8GHz. No external matching is required to achieve full band operation

Picture



Electrical Performance

$T_{BASE}=28^{\circ}C$, $V_D=+28V$, $I_{DQ}=2A$, $Z_0=50\Omega$, CW

Parameter	Min.	Typ.	Max.	Units
Frequency Range	5	—	8	GHz
Small Signal Gain	—	28	—	dB
Power Gain	—	20	—	dB
Reverse Isolation	—	45	—	dB
RF Input Port Return Loss	—	10	—	dB
Output Power	—	48	—	dBm
Drain Voltage (V_D)	—	28	—	V
Gate Current	—	2	23	mA
Supply Current (I_D)*	—	—	13	A

*Adjust Vg between -2.7V to -1.8V to achieve $I_{DQ}=2A$, and typical Vg voltage is -2.3V

Absolute Maximum Ratings

Maximum Input Power	+33dBm	Operating Temperature (T_{BASE})	-55°C~+85°C
Channel Temperature	230°C	Storage Temperature	-55°C~+165°C
Maximum V_D	+32V	V_G Range	-8V~-1.5 V
ESD Tolerance Level	Class 1B, HBM		

SuperApex, LLC

1580 S. Milwaukee Ave. Suite 405, Libertyville, IL 60048, USA
Tel: 1-847-505-8319, 1-847-573-9866
E-mail: sales@superapexco.com
Website: www.superapexco.com

SAC5008CR12



GaN MMIC Power Amplifier
5GHz~8GHz 48dBm

Rev 1.0

Typical Performance Curve

The following curves are taken from SAC5008CR12 evaluation board. De-embedding operation has been implemented. $V_D=+28V$, $I_{DQ}=2A$, $T_{BASE}=+23^{\circ}C$

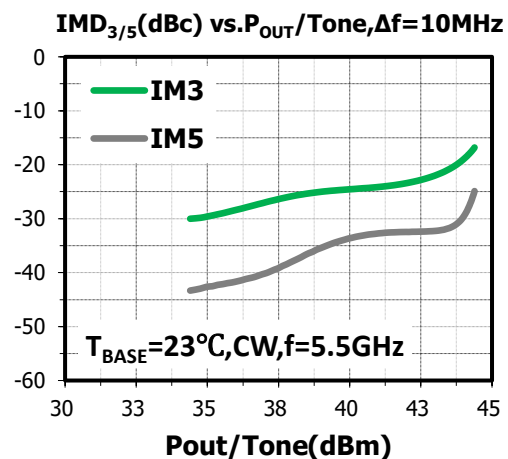
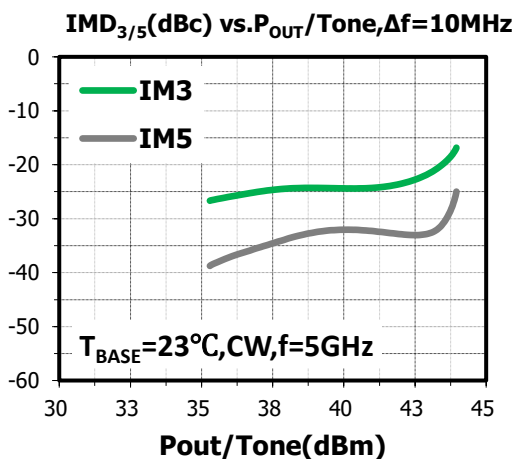
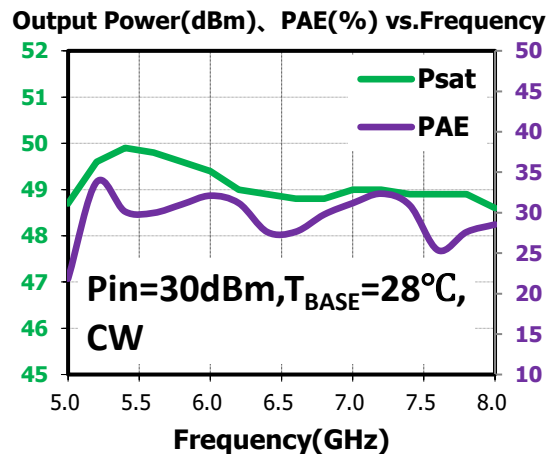
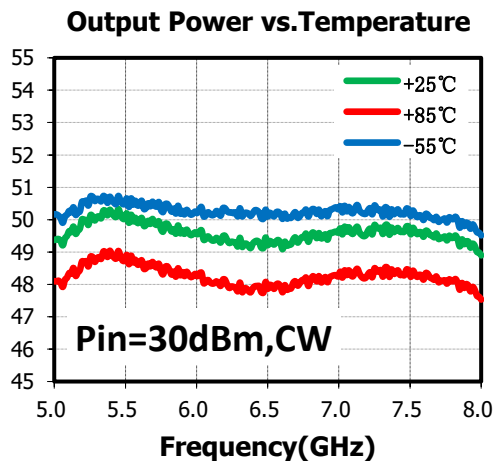
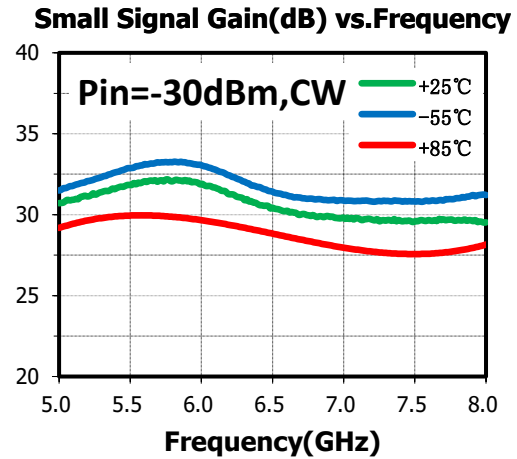
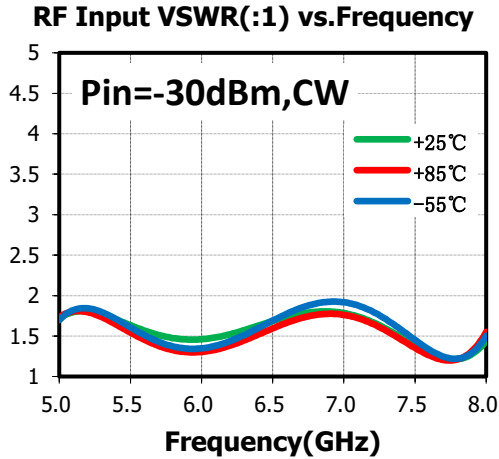

SuperApex, LLC

1580 S. Milwaukee Ave. Suite 405, Libertyville, IL 60048, USA
Tel: 1-847-505-8319, 1-847-573-9866
E-mail: sales@superapexco.com
Website: www.superapexco.com

SAC5008CR12



GaN MMIC Power Amplifier
5GHz~8GHz 48dBm

Rev 1.0

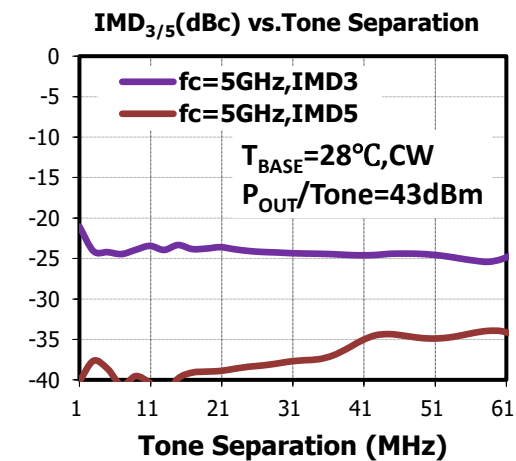
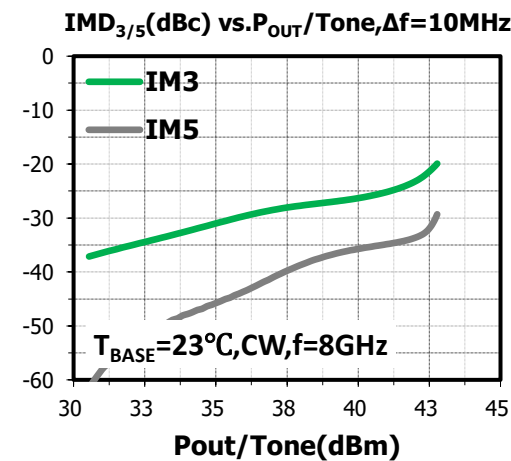
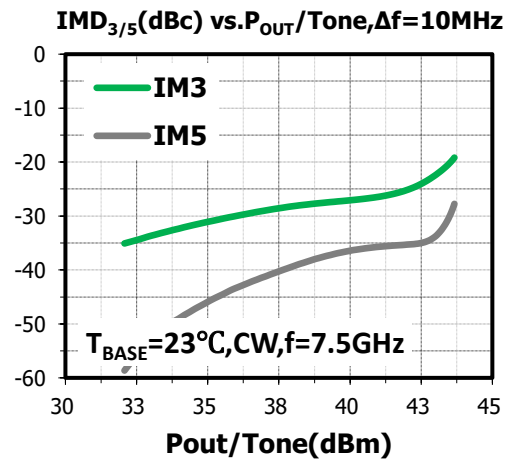
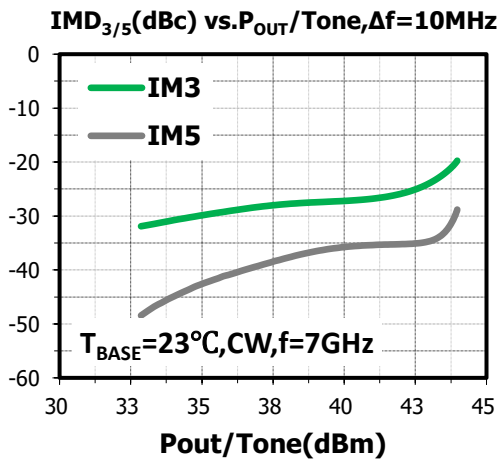
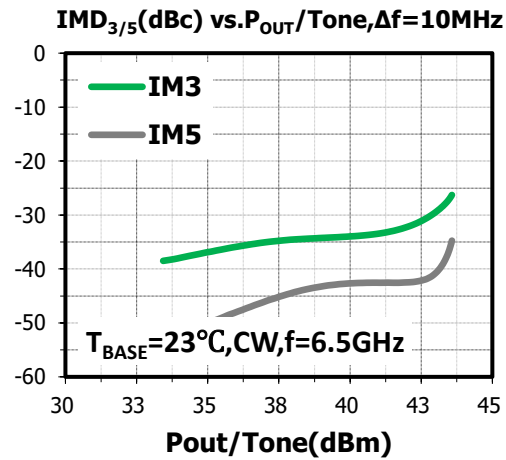
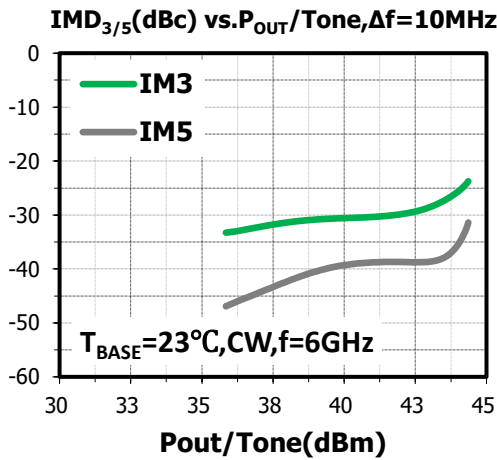

SuperApex, LLC

1580 S. Milwaukee Ave. Suite 405, Libertyville, IL 60048, USA
Tel: 1-847-505-8319, 1-847-573-9866
E-mail: sales@superapexco.com
Website: www.superapexco.com

SAC5008CR12



GaN MMIC Power Amplifier
5GHz~8GHz 48dBm

Rev 1.0

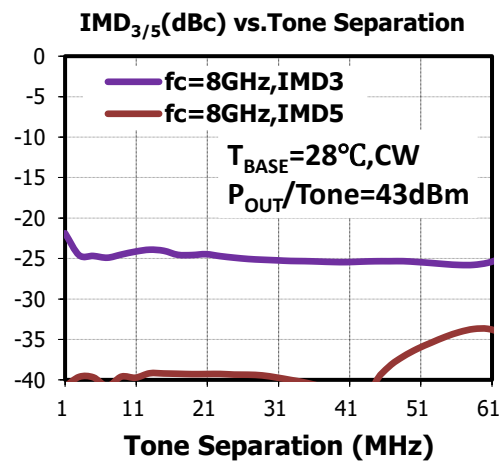
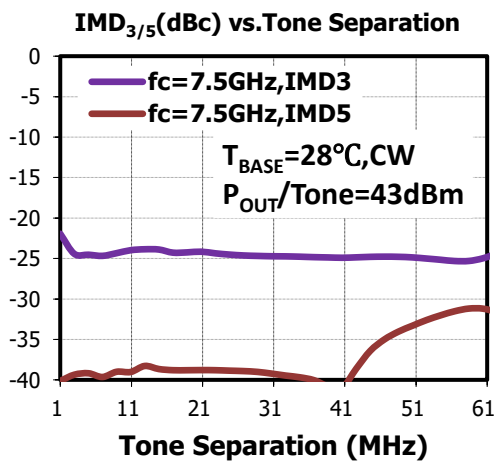
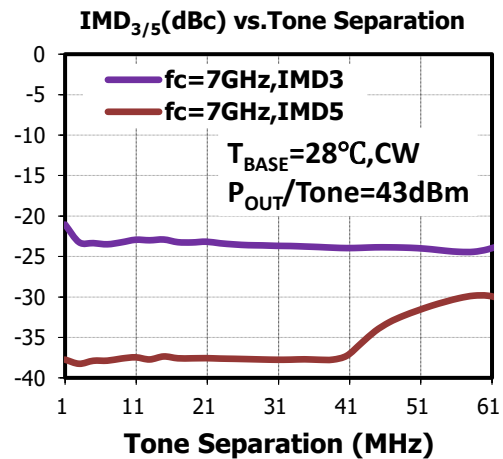
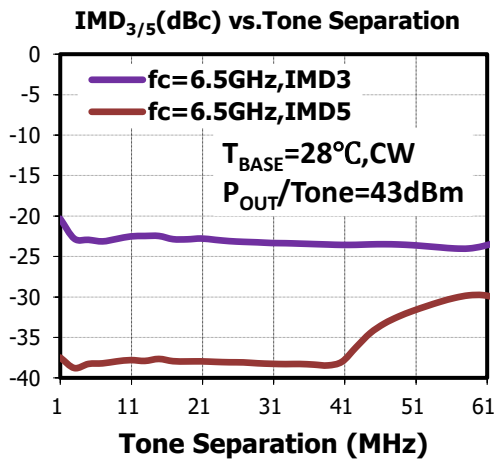
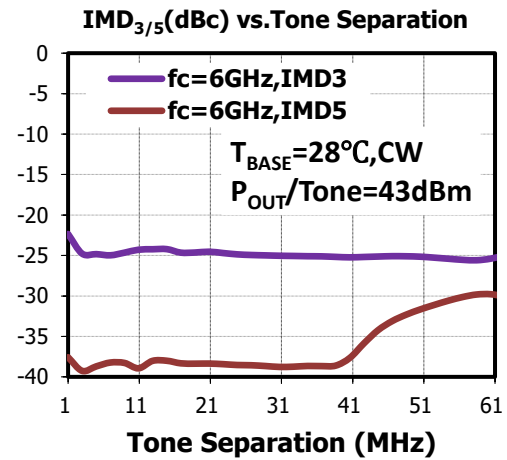
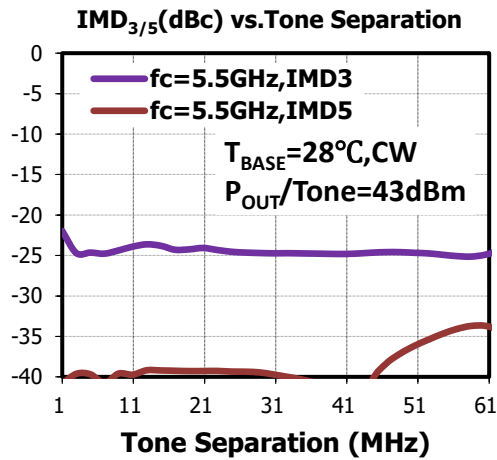

SuperApex, LLC

1580 S. Milwaukee Ave. Suite 405, Libertyville, IL 60048, USA
Tel: 1-847-505-8319, 1-847-573-9866
E-mail: sales@superapexco.com
Website: www.superapexco.com

SAC5008CR12



GaN MMIC Power Amplifier
5GHz~8GHz 48dBm

Rev 1.0

Thermal Resistance

Parameter	Conditions	Value	Unit
θ_{JC}	VD=+28V, T _{BASE} =+70°C, Pin=+30dBm, CW, f=6GHz	0.43	°C/W

Package Outline

(All dimensions in mm)

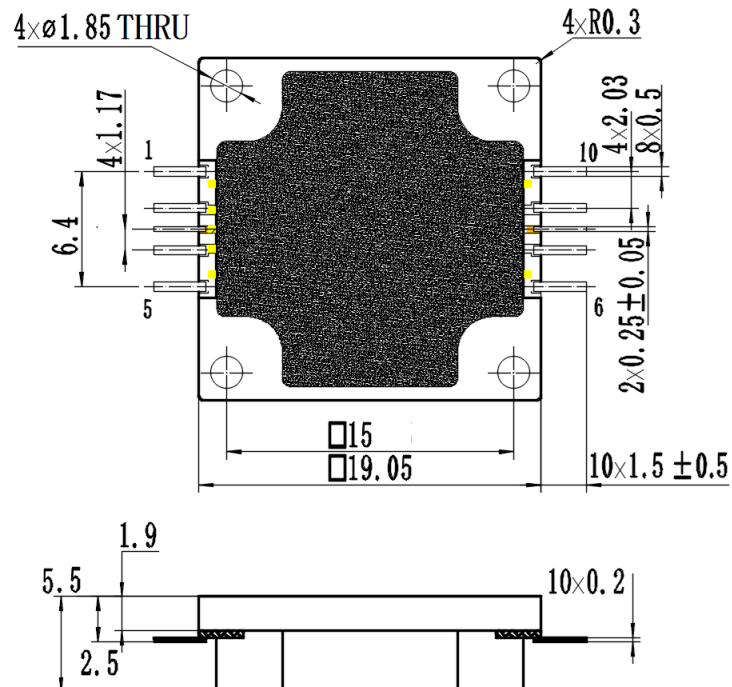

Pin Descriptions

Pin No.	Function	Pin No.	Function
1	VG1	6	VD2
2	GND	7	GND
3	RFIN	8	RFOUT
4	GND	9	GND
5	VG2	10	VD1

SuperApex, LLC

1580 S. Milwaukee Ave. Suite 405, Libertyville, IL 60048, USA
Tel: 1-847-505-8319, 1-847-573-9866
E-mail: sales@superapexco.com
Website: www.superapexco.com

SAC5008CR12



GaN MMIC Power Amplifier
5GHz~8GHz 48dBm

Rev 1.0

Application Circuit

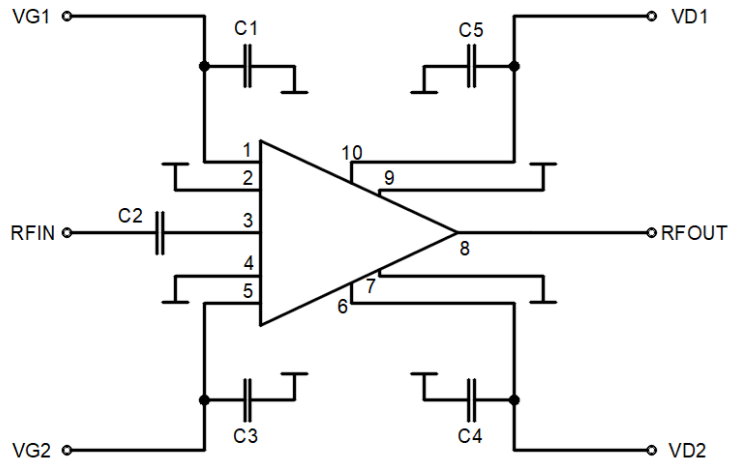

BOM

Reference Des.	Value	Part Number	Manuf.	Size
C1, C3	1000pF	—	—	0805
C4, C5	10 μ F	—	—	0805
C2	39pF	—	—	0603

Evaluation Board

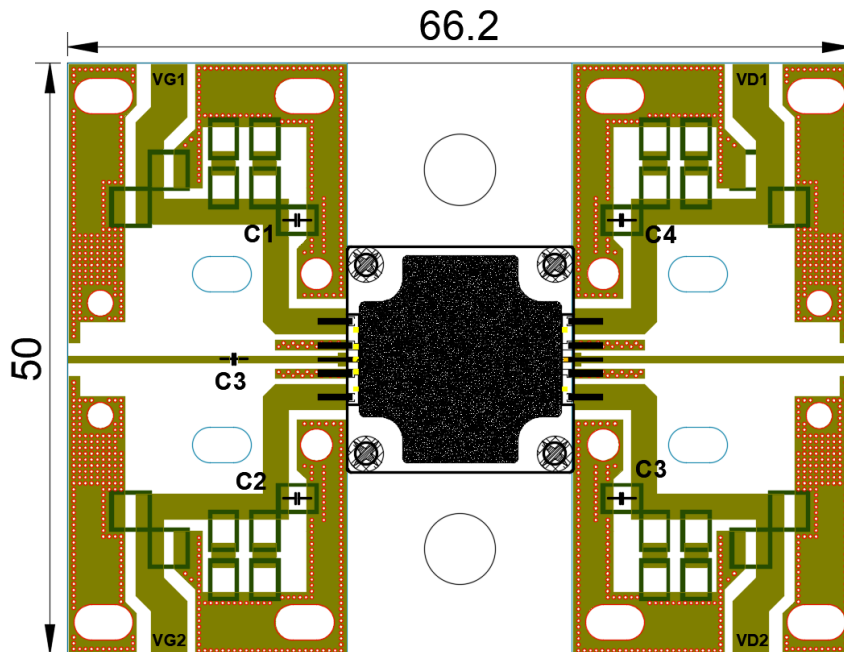

1. PCB is made from Rogers 4350b dielectric, 0.508mm thick, 0.5 oz. copper both sides,
2. Both Top and Bottom VD and VG must be biased.

SuperApex, LLC

1580 S. Milwaukee Ave. Suite 405, Libertyville, IL 60048, USA
 Tel: 1-847-505-8319, 1-847-573-9866
 E-mail: sales@superapexco.com
 Website: www.superapexco.com

SAC5008CR12



GaN MMIC Power Amplifier
5GHz~8GHz 48dBm

Rev 1.0

Notes

1. SAC5008CR12 requires a bias of drain positive voltage (VDx) and gate negative voltage (VGx). Before applying drain positive voltage, it is necessary to ensure that the gate negative voltage has been applied. When turning off, the drain positive voltage should be turned off first and then the gate negative voltage should be turned off
2. For best RF performance we recommend using 0.1mm indium shim between MMIC package and heatsink, the surface finish of the heat sink should be better than 0.8 μ m, and the surface flatness must be better than 10 μ m,
3. The flange of package may be attached using screws. Torque conditions are 6N-cm for M1.6 screw,
4. Because of high DC power dissipation, good heat sinking is required,
5. This chip is an electrostatic sensitive device,
6. The maximum soldering temperature for device pins is 400 °C/3s.

Revision History

Revision	Date	Comment
1.0	Jan. 21, 2025	First Release

SuperApex, LLC

1580 S. Milwaukee Ave. Suite 405, Libertyville, IL 60048, USA
Tel: 1-847-505-8319, 1-847-573-9866
E-mail: sales@superapexco.com
Website: www.superapexco.com